

SECT B-B

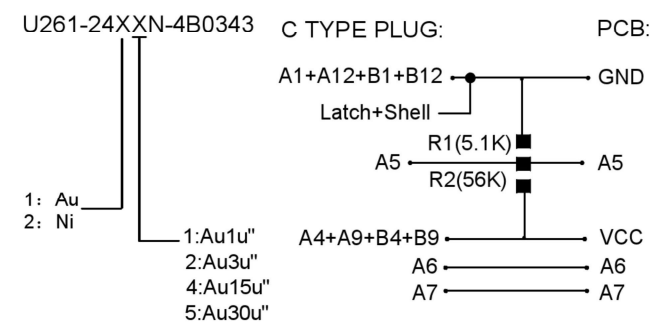

P/N	R/C
U261-24XXN-4B0342	R1(5.1K±5%)
U261-24XXN-4B0343	R2(56K±5%)

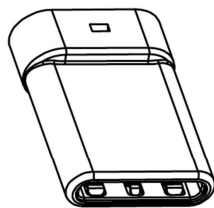
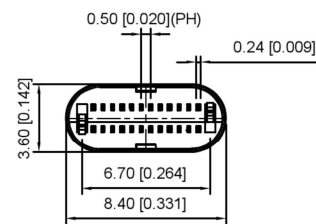
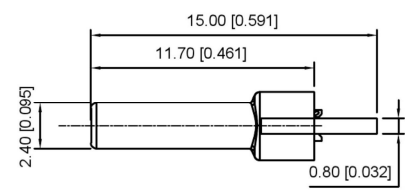
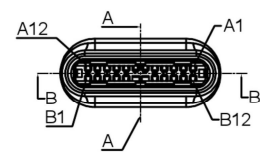

- REMARKS:
- CONTACT INSERTION AND WITHDRAW FORCE :
 - Insertion force : 5N-20N max.
 - Withdrawal force : 8N-20N.
 - Durability : 10000Cycles.
 - ELECTRIC PROPERTY :
 - Contact current rating : 3A.
 - Dielectric Strength : 100V AC(RMS).
 - Insulation Resistance : 100 megaohms min.
 - Contact resistance :
 - 40mOhms MAX.FOR VBUS,GND AND OTHER CONTACT
 - 50mOhms MAX.AFTER ENVIRONMENT TEST
 - AMBIENT TEMPERATURE :
 - Operating temperature : -55°C to +85°C.

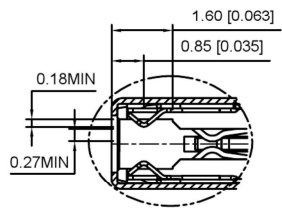
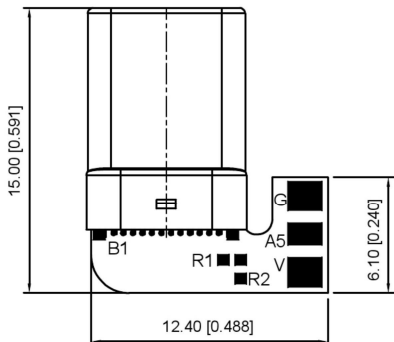

D
2:1

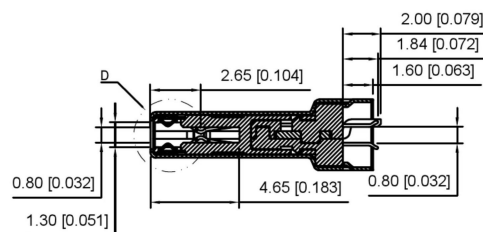

SECT A-A

A12	A11	A10	A9	A8	A7	A6	A5	A4	A3	A2	A1
GND	RX2+	RX2-	Vbus	SBU1	D-	D+	CC	Vbus	TX1-	TX1+	GND
GND	TX2+	TX2-	Vbus	Vconn			SBU2	Vbus	RX1-	RX1+	GND
B1	B2	B3	B4	B5	B6	B7	B8	B9	B10	B11	B12

ITEM	DESCRIPTION	MATERIAL	REMARKS
6	Shrapnel	SUS T=0.10mm	
5	Shell	SUS T=0.15mm	Ovep-plating : Ni
4	Terminal	C7025 T=0.15mm	Ovep-plating:Au Ni/Sn
3	Latch	SUS T=0.4mm	
2	Housing	LCP	UL94-0
1	Housing Stopper	LCP	UL94-0

				ANGULAR	±5°	 SWITCH CONNECTOR	DSND		SCALE: N/A	MODEL TYPE:	Type-C 3.1	
				L ≤ 4	±0.2		DWN		VIEW:	PART NO.:		
				4 < L ≤ 16	±0.3		CHKD		UNIT: mm/in	DWG NO.:		
				16 < L ≤ 63	±0.4		APPD		SIZE: A4	U261-24XXN-4B0343		
				L > 63	±0.5						WEIGHT	SHEET
REVISIONS				UNSPECIFIED TOLERANCES		KE SI DA ELECTRONIC TECHNOLOGY CO., LTD						
WWW.BODONGKAIGUAN.NET				WWW.CKJACK.COM							1/1	A0