

SECT B-B

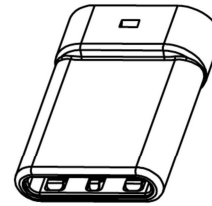

U261-24XXN-4B0416

1: Au
2: Ni

1:Au1u"
2:Au3u"
4:Au15u"
5:Au30u"

C TYPE PLUG: PCB:

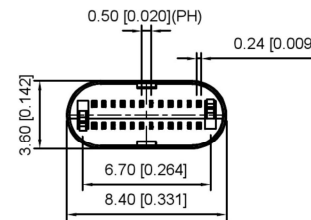
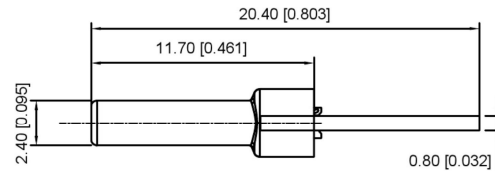
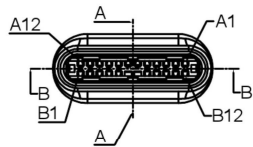
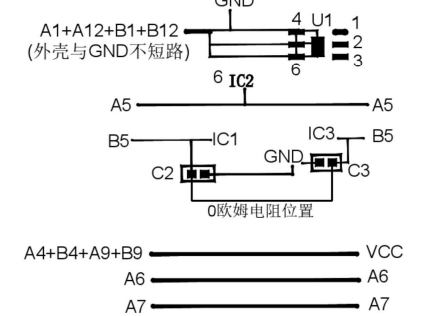

P/N	R/C
U261-24XXN-4B0416	C2, C3(0.1uF X5R 6.3V) IC, HUSB330DN6(DFN-6L)

REMARKS:

- CONTACT INSERTION AND WITHDRAW FORCE :
 - Insertion force : 5N-20N max.
 - Withdrawal force : 8N-20N.
 - Durability : 10000Cycles.
- ELECTRIC PROPERTY :
 - Contact current rating : 3A.
 - Dielectric Strength : 100V AC(RMS).
 - Insulation Resistance : 100 megaohms min.
 - Contact resistance :
 - 40mOhms MAX.FOR VBUS,GND AND OTHER CONTACT
 - 50mOhms MAX.AFTER ENVIRONMENT TEST
- AMBIENT TEMPERATURE :
 - Operating temperature : -55°C to +85°C.

0欧姆电阻位置

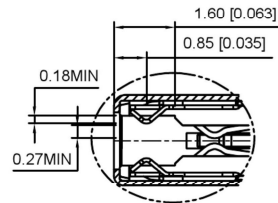
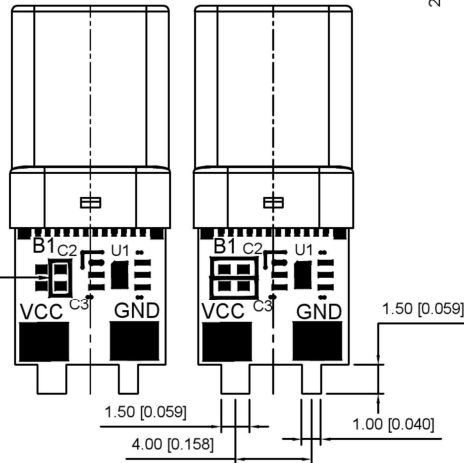

D
2:1

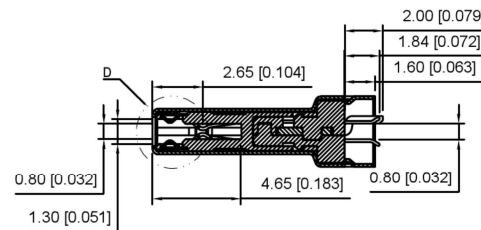

SECT A-A

A12	A11	A10	A9	A8	A7	A6	A5	A4	A3	A2	A1
GND	RX2+	RX2-	Vbus	SBU1	D-	D+	CC	Vbus	TX1-	TX1+	GND
GND	TX2+	TX2-	Vbus	Vconn			SBU2	Vbus	RX1-	RX1+	GND
B1	B2	B3	B4	B5	B6	B7	B8	B9	B10	B11	B12

ITEM	DESCRIPTION	MATERIAL	REMARKS
6	Shrapnel	SUS T=0.10mm	
5	Shell	SUS T=0.15mm	Ovep-plating : Ni
4	Terminal	C7025 T=0.15mm	Ovep-plating: Au Ni/Sn
3	Latch	SUS T=0.4mm	
2	Housing	LCP	UL94-0
1	Housing Stopper	LCP	UL94-0

REVISIONS	DATE	REVISED	APPROVED	UNSPECIFIED TOLERANCES
				ANGULAR ±5°
				L ≤ 4 ±0.2
				4 < L ≤ 16 ±0.3
				16 < L ≤ 63 ±0.4
				L > 63 ±0.5

KSD
SWITCH CONNECTOR

DSND	SCALE: N/A	MODEL TYPE: Type-C 3.1
DWN	VIEW:	PART NO.:
CHKD	UNIT: mm/in	DWG NO.: U261-24XXN-4B0416
APPD	SIZE: A4	WEIGHT SHEET REVISION
		1/1 A0