

U262-06XN-4BFC12

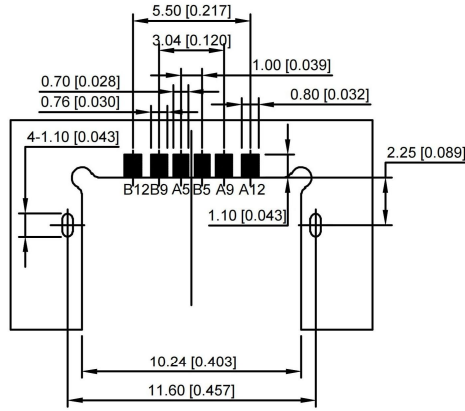
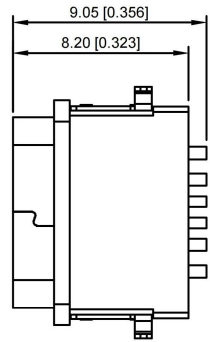
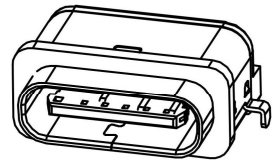

1:0.8u"
2:5u"
3:10u"

W:WHITE
B:BLACK

1:PBT
2:PA6T
3:PA9T
4:LCP

RECOMMENDED P.C.B LAYOUT
TOLERANCE UNSPECIFIED ±0.05mm

NOTES:

SPECIFICATION:

- CURRENT RATING: 3.0A MAX
- VOLTAGE: 100 VAC
- TEMPERATURE RANGE: -30 ~85
- CONTACT RESISTANCE: 40 MILLIONHM MAX
- INSULATION RESISTANCE: 100 MEGOHMS MIN
- INSERTION FORCE: 5N~20N
- UNMATING FORCE: 8N~20N
- DURABILITY: 10,000 CYCLES
- WATER PROOFNESS: THIS PRODUCT IS BASED ON IPX7

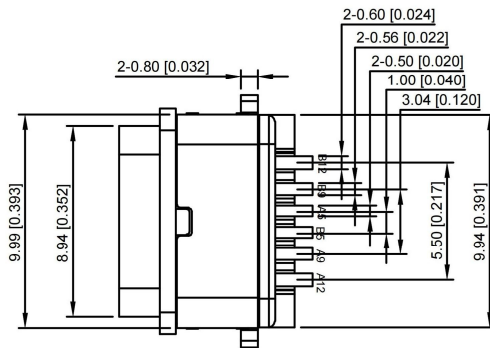
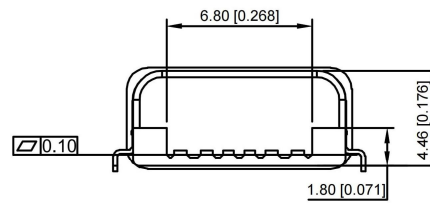
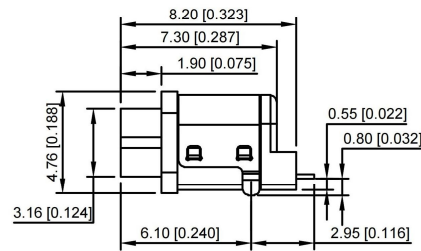
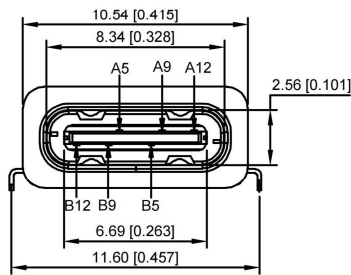

A5	CC1	B12	GND
A9	VBUS	B9	VBUS
A12	GND	B5	CC2
PIN	SIGNAL NAME	PIN	SIGNAL NAME

NO.	DESCRIPTION	MATERIAL	REMARKS	QTY
5	SHELL	STAINLESS STEEL	NI Plated	1PCS
4	SHIELDING PLATE	STAINLESS STEEL	NI Plated	1PCS
3	CONTACT	COPPER ALLOY	TIN/Au/NI Plated	1SET
2	SHELL HOUSING	HIGH TEMPERATURE PLASTIC	BLACK	1PCS
1	HOUSING	HIGH TEMPERATURE PLASTIC	BLACK	1PCS

REVISIONS				DATE	REVISED	APPROVED	UNSPECIFIED TOLERANCES	DSND	SCALE: N/A	MODEL TYPE: Type-C 3.1
							ANGULAR ±5°			
							L ≤ 4 ±0.2	DWN	VIEW:	PART NO.:
							4 < L ≤ 16 ±0.3	CHKD	UNIT: mm/in	DWG NO.:
							16 < L ≤ 63 ±0.4	APPD	SIZE: A4	U262-06XN-4BF712
							L > 63 ±0.5			WEIGHT
WWW.BODONGKAIGUAN.NET WWW.CKJACK.COM WWW.KSDKG.COM								KE SI DA ELECTRONIC TECHNOLOGY CO., LTD		SHEET 1/1
										REVISION A0

