

SECT B-B

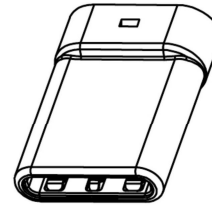

U261-24XXN-4B0174

- 1: Au1u"
- 2: Au3u"
- 4: Au15u"
- 5: Au30u"

C TYPE PLUG:

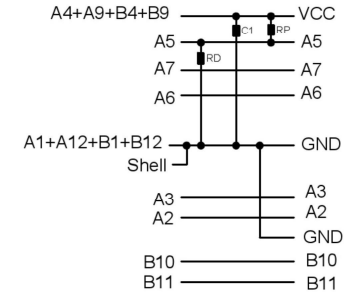

PCB:

P/N	R/C
U261-24XXN-4B0281	C(10nF/30V MIN)
U261-24XXN-4B0165	C(10nF/30V MIN)+RD(5.1KΩ)
U261-24XXN-4B0174	C(10nF/30V MIN)+RP(56KΩ)

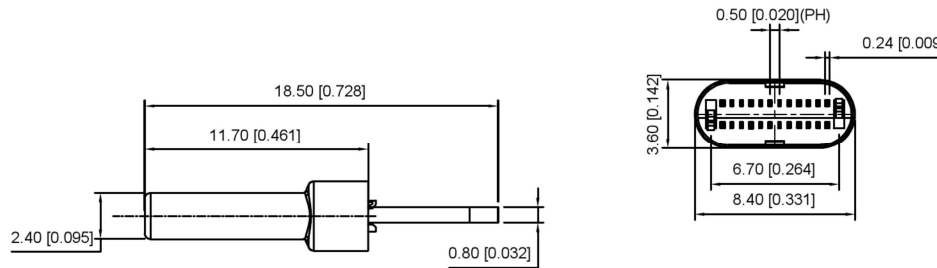
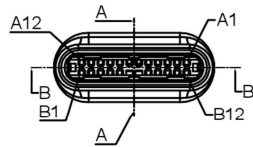

REMARKS:

1. CONTACT INSERTION AND WITHDRAW FORCE :
 1. Insertion force : 5N-20N max.
 2. Withdrawal force : 8N-20N.
 3. Durability : 10000Cycles.
2. ELECTRIC PROPERTY :
 1. Contact current rating : 3A.
 2. Dielectric Strength : 100V AC(RMS).
 3. Insulation Resistance : 100 megaohms min.
 4. Contact resistance :
 - 40mOhms MAX.FOR VBUS,GND AND OTHER CONTACT
 - 50mOhms MAX.AFTER ENVIRONMENT TEST
3. AMBIENT TEMPERATURE :
 1. Operating temperature : -55°C to +85°C.

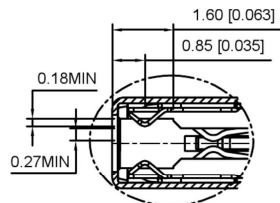
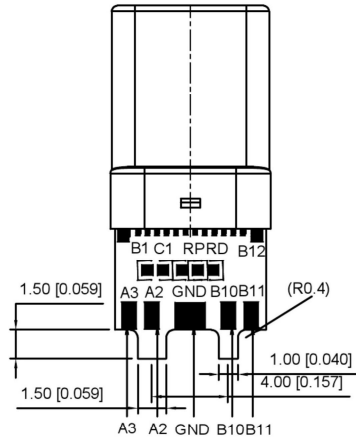

D
2:1

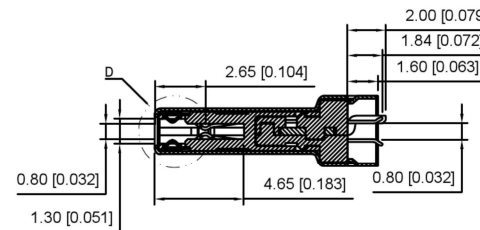

SECT A-A

A12	A11	A10	A9	A8	A7	A6	A5	A4	A3	A2	A1
GND	RX2+	RX2-	Vbus	SBU1	D-	D+	CC	Vbus	TX1-	TX1+	GND
GND	TX2+	TX2-	Vbus	Vconn			SBU2	Vbus	RX1-	RX1+	GND
B1	B2	B3	B4	B5	B6	B7	B8	B9	B10	B11	B12

ITEM	DESCRIPTION	MATERIAL	REMARKS
6	Shrapnel	SUS T=0.10mm	
5	Shell	SUS T=0.15mm	Ovep-plating: Ni
4	Terminal	C7025 T=0.15mm	Ovep-plating: Au Ni/Sn
3	Latch	SUS T=0.4mm	
2	Housing	LCP	UL94-0
1	Housing Stopper	LCP	UL94-0

REVISIONS				DATE	REVISED	APPROVED	UNSPECIFIED TOLERANCES	DSND	SCALE: N/A	MODEL TYPE: Type-C 3.1
							ANGULAR ±5°	DWN	VIEW:	PART NO.:
							L ≤ 4 ±0.2	CHKD	UNIT: mm/in	DWG NO.:
							4 < L ≤ 16 ±0.3	APPD	SIZE: A4	U261-24XXN-4B0174
							16 < L ≤ 63 ±0.4			
							L > 63 ±0.5			
WWW.BODONGKAIGUAN.NET WWW.CKJACK.COM WWW.KSDKG.COM								KE SI DA ELECTRONIC TECHNOLOGY CO., LTD		WEIGHT SHEET REVISION
										1/1 A0