

SECT B-B

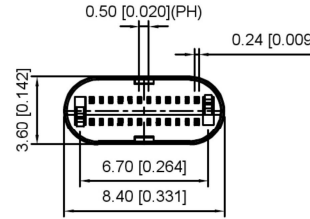
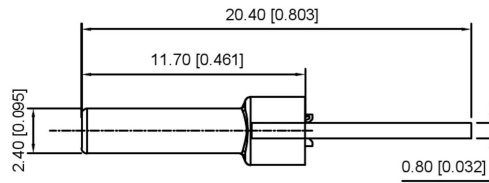
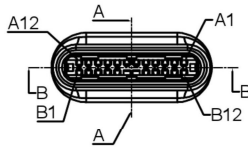

U261-24XXN-4B0355

1: Au
2: Ni

1:Au1u"
2:Au3u"
4:Au15u"
5:Au30u"

C TYPE PLUG:

PCB:

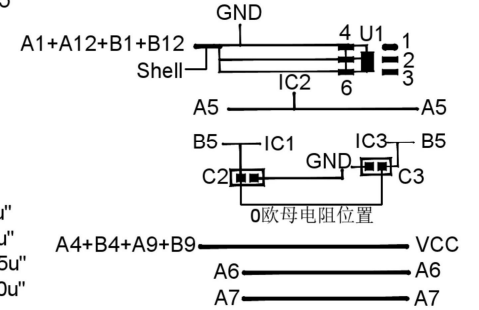

REMARKS:

- CONTACT INSERTION AND WITHDRAW FORCE :
 - Insertion force : 5N-20N max.
 - Withdrawal force : 8N-20N.
 - Durability : 10000Cycles.
- ELECTRIC PROPERTY :
 - Contact current rating : 3A.
 - Dielectric Strength : 100V AC(RMS).
 - Insulation Resistance : 100 megaohms min.
 - Contact resistance : 40mOhms MAX.FOR VBUS,GND AND OTHER CONTACT 50mOhms MAX.AFTER ENVIRONMENT TEST
- AMBIENT TEMPERATURE :
 - Operating temperature : -55°C to +85°C.

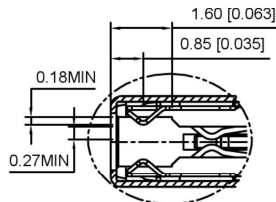
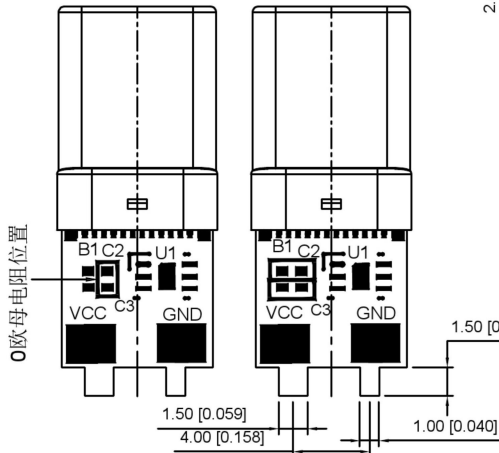

D
2:1

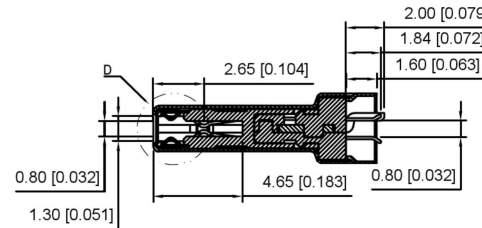

SECT A-A

A12	A11	A10	A9	A8	A7	A6	A5	A4	A3	A2	A1
GND	RX2+	RX2-	Vbus	SBU1	D-	D+	CC	Vbus	TX1-	TX1+	GND
GND	TX2+	TX2-	Vbus	Vconn			SBU2	Vbus	RX1-	RX1+	GND
B1	B2	B3	B4	B5	B6	B7	B8	B9	B10	B11	B12

6	Shrapnel	SUS T=0.10mm	
5	Shell	SUS T=0.15mm	Ovep-plating: Ni
4	Terminal	C7025 T=0.15mm	Ovep-plating:Au Ni/Sn
3	Latch	SUS T=0.4mm	
2	Housing	LCP	UL94-0
1	Housing Stopper	LCP	UL94-0
ITEM	DESCRIPTION	MATERIAL	REMARKS

				ANGULAR	±5°
				L ≤ 4	±0.2
				4 < L ≤ 16	±0.3
				16 < L ≤ 63	±0.4
				L > 63	±0.5
				UNSPECIFIED TOLERANCES	
REVISIONS					
	DATE	REVISED	APPROVED		
WWW.BODONGKAIGUAN.NET WWW.CKJACK.COM WWW.KSDKG.COM					

DSND		SCALE: N/A	MODEL TYPE: Type-C 3.1
DWN		VIEW:	PART NO.:
CHKD		UNIT: mm/in	DWG NO.:
APPD		SIZE: A4	U261-24XXN-4B0355
KE SI DA ELECTRONIC TECHNOLOGY CO., LTD			WEIGHT SHEET REVISION
			1/1 A0

