

RECOMMENDED PCB LAYOUT
TOL:±0.05

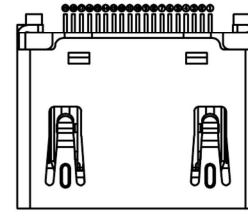

A71-05H9-1X1N2

1:AU 1U"
5:AU 15U"
6:AU 30U"

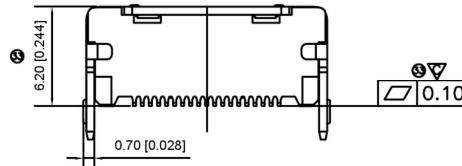
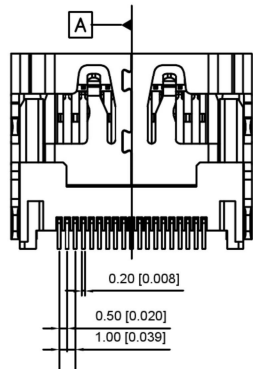
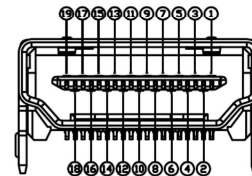
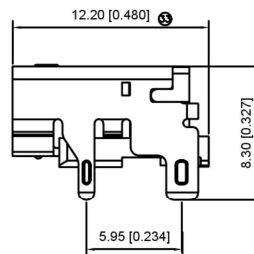
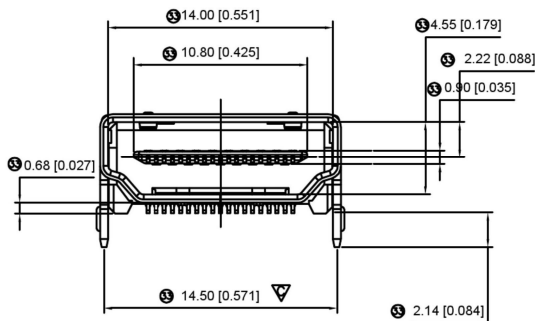

NOTES:

- MATERIALS:
HOUSING: THERM-PLASTIC+30%GLASS FILLED, BLACK, UL94V-0
CONTACTS: COPPER ALLOY
SHELL: COPPER ALLOY
- PLATING:
SHELL: NICKEL PLATING OVERALL.
CONTACT: GOLD PLATING OVER NICKEL IN CONTACT,
NICKEL PLATING OVERALL
- RoHS COMPLIANT
- DIMENSIONS MARKED ⊕ SHOULD BE MEASURED BY FAI.
- DIMENSIONS MARKED ▽ MUST BE CONTROLLED IN QIP.

				ANGLAR	±5°	 KE SI DA ELECTRONIC TECHNOLOGY CO., LTD	DSND	SCALE: N/A	MODEL TYPE: HDMI CONNECTOR	
				L ≤ 4	±0.2		DWN	VIEW: ⊕	PART NO.:	
				4 < L ≤ 16	±0.3		CHKD	UNIT: mm/in	DWG NO.:	
				16 < L ≤ 63	±0.4		APPD	SIZE: A4	A71-05H9-1X1N2	
				L > 63	±0.5				WEIGHT	SHEET
REVISIONS				UNSPECIFIED TOLERANCES					1/1	A0
WWW.BODONGKAIGUAN.NET WWW.CKJACK.COM WWW.KSDKG.COM										