

REV.	ECN.NO.	MODIFY.CONTENT	DATE
A		初版发行	10/25'17
B	GE18010**	增加其他视图	01/12'18

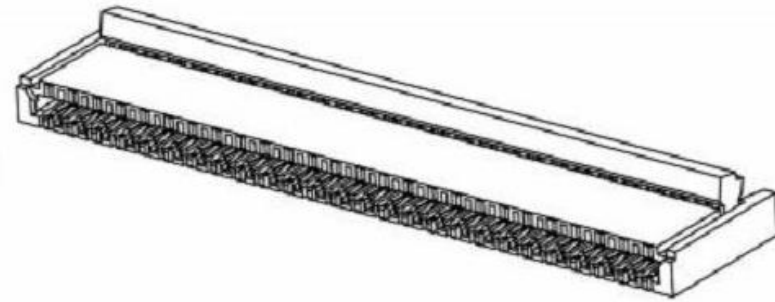
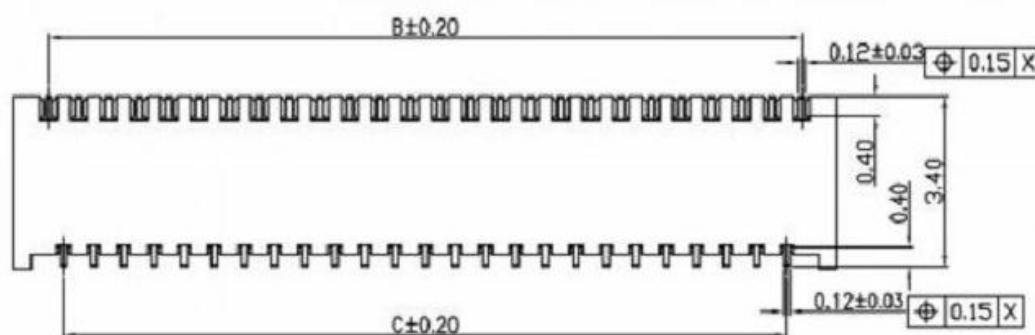
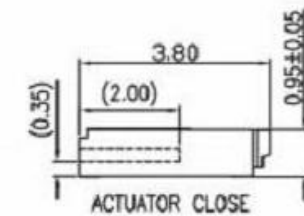
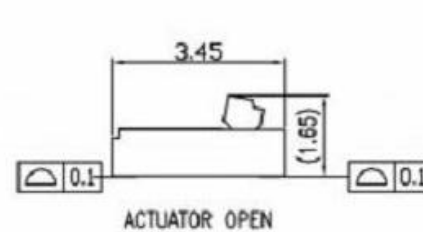
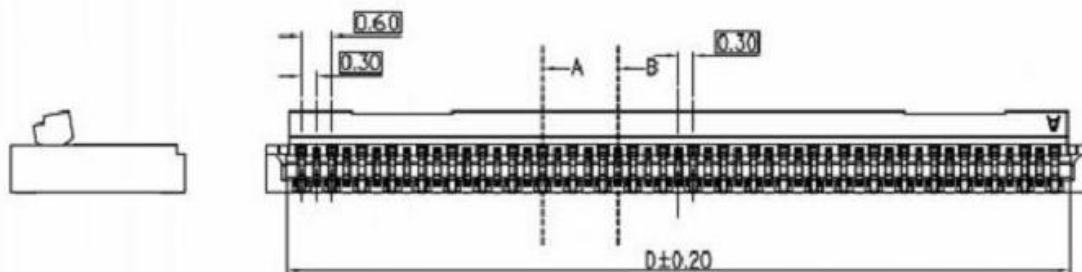
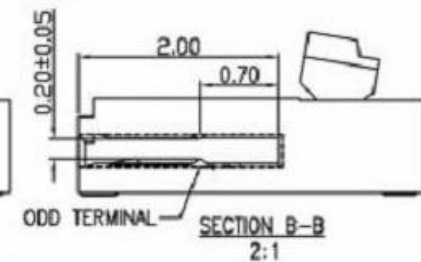
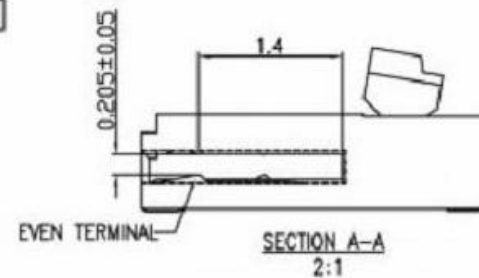
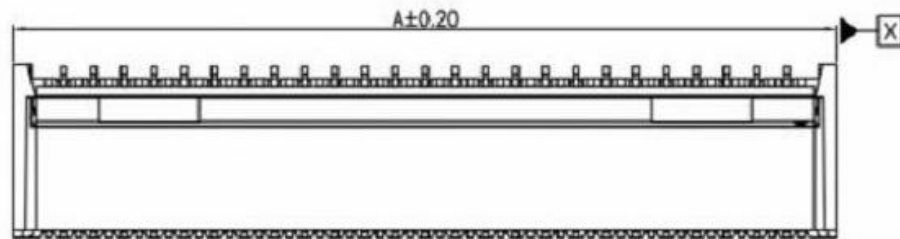

GENERAL TOLERANCE		DRAWN	Xiaohu.Liang	Oct.25-17	SCALE	PART NO.
X.±0.30	x.'±1'	CHECKED	Cunfa.Jie	Oct.25-17	20/3	TITLE 0.3 PITCH FPC CONNECTOR
.X±0.25	.x'±0.1'	APPROVED	Qunyu.Li	Oct.25-17	UNITS	mm
.XX±0.20		File NO.				成品SPEC图
.XXX±0.10		REV.				
SHEET	1/2	Q'TY	1	REV.	B	

注：此文件为双方检验的唯一标准

广东科斯达开关厂

REV.	ECN.NO.	MODIFY.CONTENT	DATE
A		初版发行	10/25'17
B	GE18010**	增加其他视图	01/12'18

NOTES:

Insulator: LCP UL 94V-0( Color: Natural)  
 Actuator: PA9T UL 94V-0( Color: Black)  
 Terminal: phosphor copper C5240 Plating:  
 Gold plating at contact and solder  
 area over all Ni 40u"min plating  
 Current Rating: 0.3A AC/DC  
 Voltage Rating: 50V AC/DC Max  
 Temperature Range: -40°C~+105°C  
 Contact Resistance: 100 mΩ Max  
 Insulation Resistance: 50 MΩ Min  
 Withstanding Voltage: 125V AC/minute

Gold plating  
 H: 3u" min  
 E: 5u" min  
 PIN number

00: Rohs  
 HF: HALOGEN FREE  
 Reel packing  
 Natural color

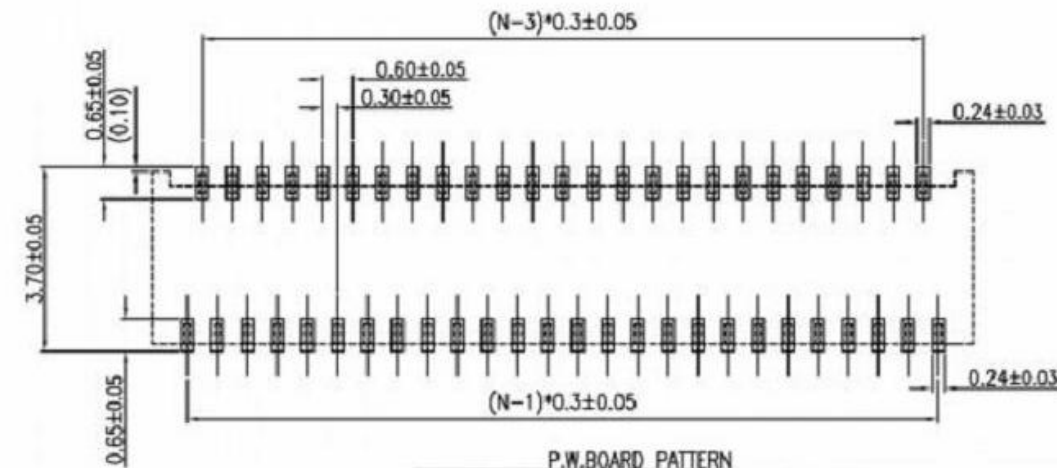

P.W. BOARD PATTERN  
 RECOMMENDED METAL MASK THICKNESS 0.1mm

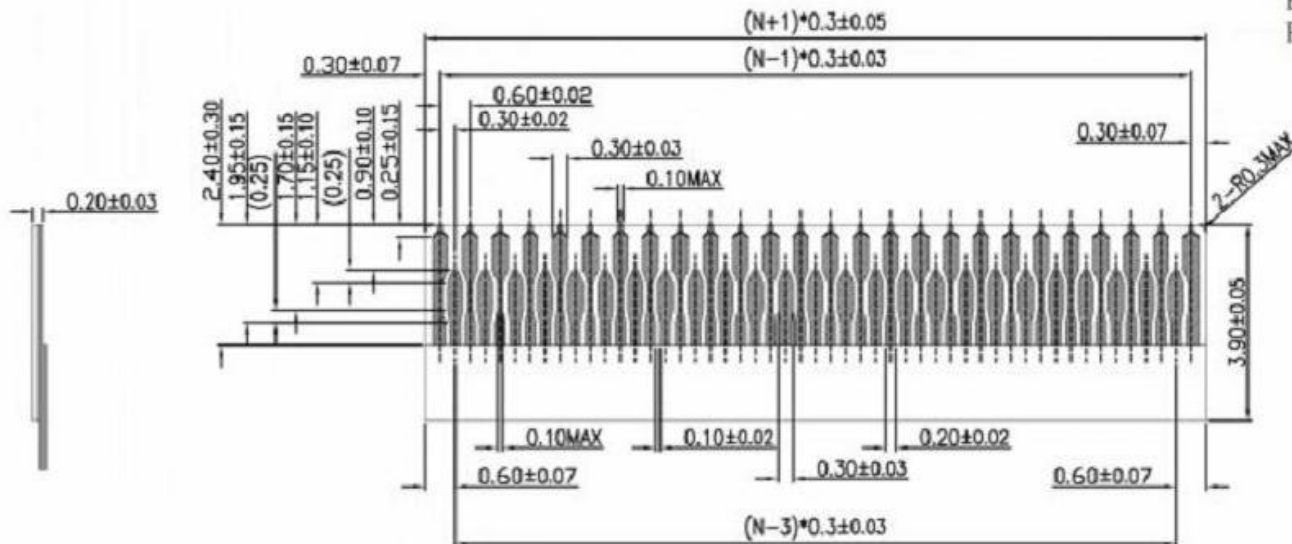

APPLY FPC RECOMMENDED DIM  
 (THICKNESS 0.20±0.03)

CIRCUITES	DIMENSION			
	A	B	C	D
11	4.4	3.0	2.4	3.6
19	6.8	5.4	4.8	6.0
23	8.0	6.6	6.0	7.2
25	8.6	7.2	6.6	7.8
33	11.0	9.6	9.0	10.2
37	12.2	10.8	10.2	11.4
39	12.8	11.4	10.8	12.0
41	13.4	12.0	11.4	12.6
45	14.6	13.2	12.6	13.8
51	16.4	15.0	14.4	15.6
61	19.4	18.0	17.4	18.6

GENERAL TOLERANCE		DRAWN	Xiaohui.song	Oct.25-17	SCALE	PART NO.
X.±0.30	x.'±1'	CHECKED	Cunfa.lai	Oct.25-17	20/3	TITLE
.X±0.25	.x'±0.1'	APPROVED	Qunyu.li	Oct.25-17	UNITS	mm
.XX±0.20		File NO.				成品SPEC图
.XXX±0.10		REV.				
SHEET	2/2	Q'TY	1	B		

广东科斯达开关厂

注: 此文件为双方检验的唯一标准

REV.	ECN.NO.	MODIFY.CONTENT	DATE
A		初版发行	10/25/17

NOTES :

- MATERIAL :  
COVER TAPE : P.S T=0.05  
CARRIER TAPE : P.S T=0.30  
REEL : PS  
CARTON: CORRUGATED FIBER
- DIMENSION :  
REEL : SEE DRAWING  
SHIPPING BOX: 350X350X300mm
- QUANTITY : SEE TABLE
- PEELING RESISTANCE : 30gf~100gf (for 12~56mm)
- PEELING SPEED : 300mm/MINUTES

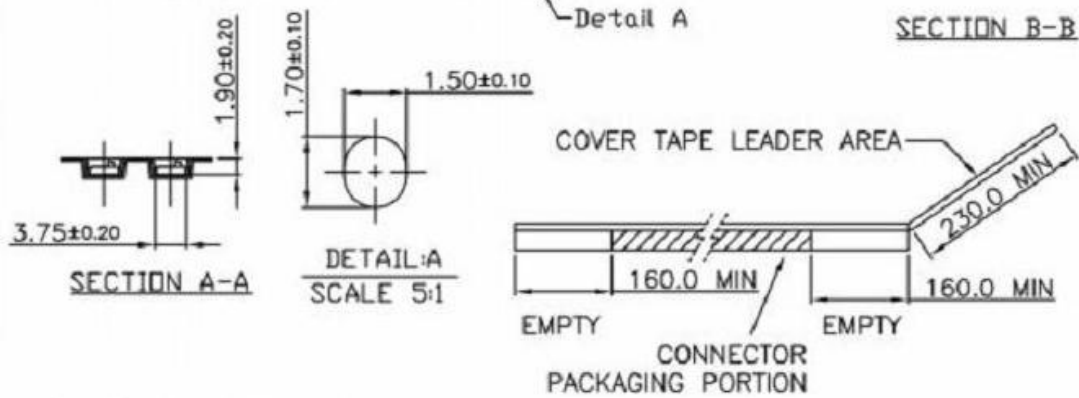
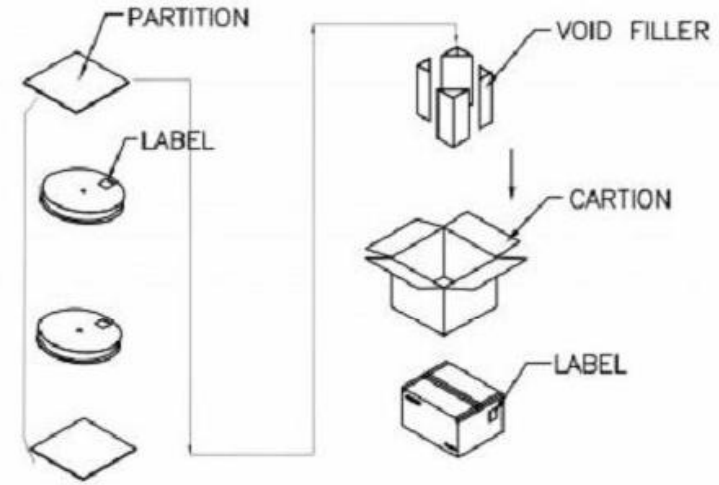
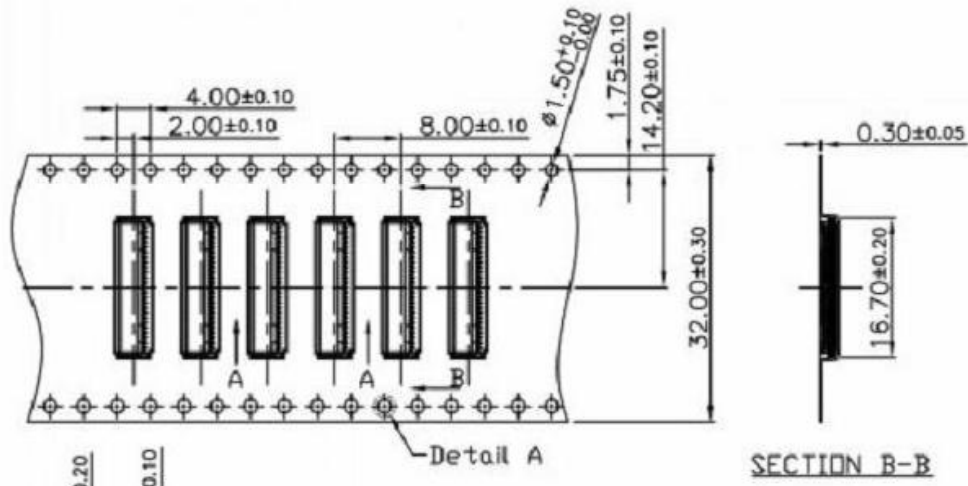
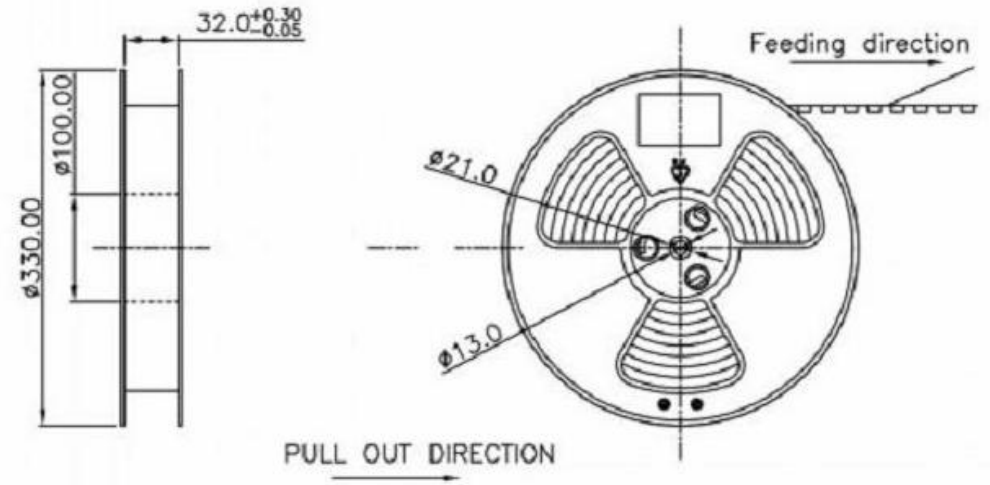

3800	3	11400
PCS/REEL	REEL/BOX	TOTAL Q'TY

GENERAL TOLERANCE		DRAWN	Xiaohui.song	Oct.25-17	SCALE	PART NO.	
X±0.40	x.'±1'	CHECKED	Cunfa.lai	Oct.25-17	N/A	TITLE	0.3 PITCH FPC CONNECTOR
.X±0.30	.x'±0.1'	APPROVED	Qunyu.li	Oct.25-17	UNITS	mm	成品包装图
.XX±0.25		File NO.					
.XXX±0.10		REV.					
SHEET	1/1	Q'TY	1	A			

广东科斯达开关厂

注：此文件为双方检验的唯一标准