

REV	ECN NO	DESCRIPTION	DATE	NAME
A		NEW	11/21-'19	LZM

**RoHS**

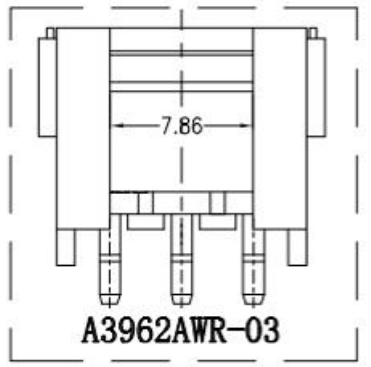
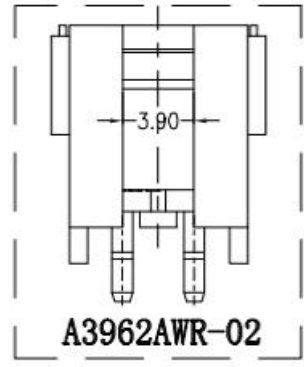
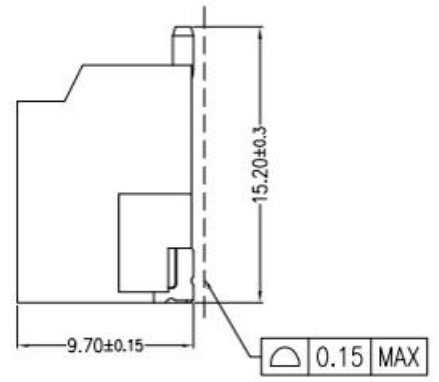
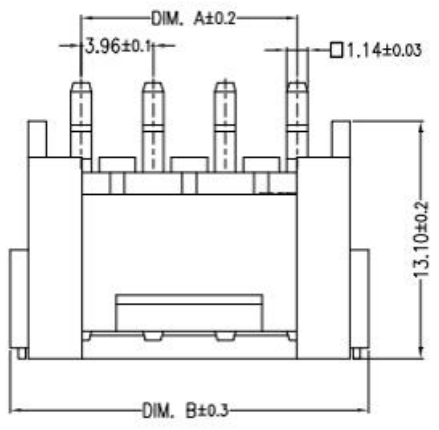

**主要技术参数 Main Specifications**

- 线 数 (Poles) : 02 to 16
- 接触电阻 (Contact resistance): ≤20m Ω
- 绝缘电阻 (Insulation resistance): ≥1000M Ω
- 额定电压 (Rated voltage): 250V AC DC
- 额定电流 (Rated current): 7.0A AC DC
- 耐 电 压 (Withstand Voltage): 1500V AC/minute
- 温度范围 (Temperature Range): -25°C~+105°C

**ORDER INFORMATION:**

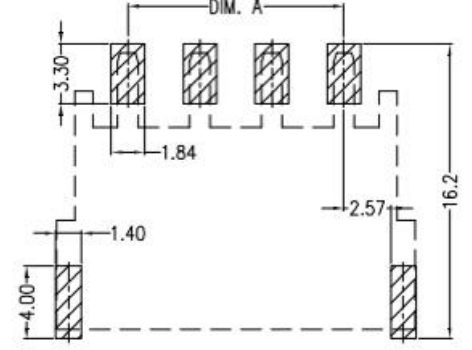
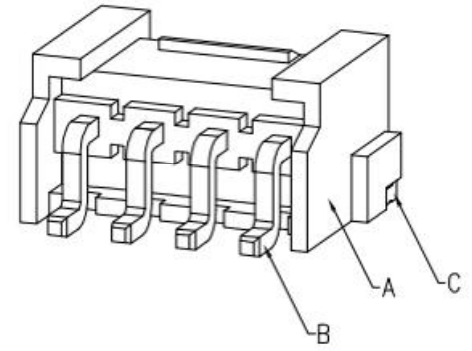
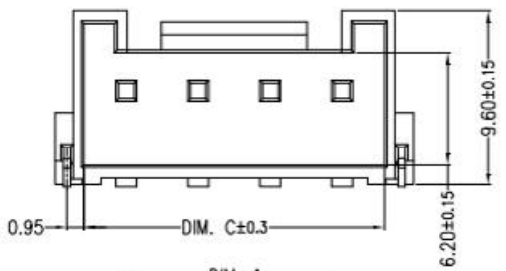
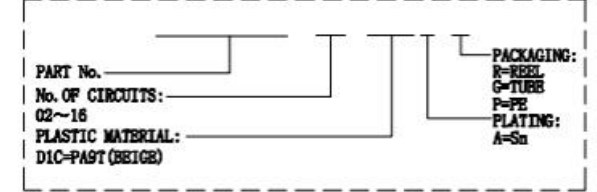

**Mating PCB detail**

Circuits	Dimensions (mm)		
	DIM A	DIM B	DIM C
02	3.96	11.88	8.60
03	7.92	15.84	12.56
04	11.88	19.80	16.52
05	15.84	23.76	20.48
06	19.80	27.72	24.44
07	23.76	31.68	28.40
08	27.72	35.64	32.36
09	31.68	39.60	36.32
10	35.64	43.56	40.28

STANDARD TOLERANCE (EXCEPT SPECIFIED)	
LINER	ANGLES
0.0 ±0.30	0.° ±3°
.00 ±0.20	.0° ±2°
.000 ±0.10	.00° ±1°

**广东科斯达开关厂**

TITLE	3.96MM PITCH 90° WAFER SMT TYPE	DRAWN BY	LZM	11/21-'19
PART NO		CHECKED BY		
DRAWING NO		APPROVED BY		
SCALE	1:1	UNIT	mm	PAGE 1/1
				SIZE A4

C	SOLDER TAB	2PCS	Brass	Sn-plated
B	CONTACT	02~10PCS	Brass	Sn-plated
A	PEDESTAL	1 PCS	PA9T	UL 94V-0, COLOR:BEIGE
ITEM	COMPONENT	Q'TY	MATERIAL	FINISH