

RoHS

REV	ECN NO	DESCRIPTION	DATE	NAME
A		NEW	11/21-'19	LZM

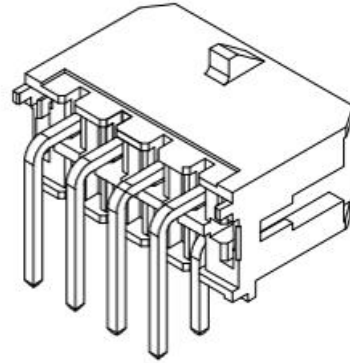
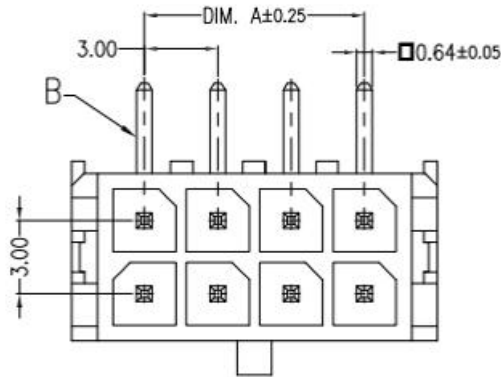

Pin NO.	Dimensions (mm)	
	DIM. A	DIM. B
2*03	6.00	12.05
2*04	9.00	15.05

主要技术参数 Main Specifications

线数 (Poles) :02 to 24

接触电阻 (Contact resistance): ≤10m Ω

绝缘电阻 (Insulation resistance): ≥1000M Ω

额定电压 (Rated voltage): 250V AC DC

额定电流 (Rated current): 5.0A AC DC

耐电压 (Withstand Voltage): 1500V AC/minute

温度范围 (Temperature Range): -25°C ~ +85°C

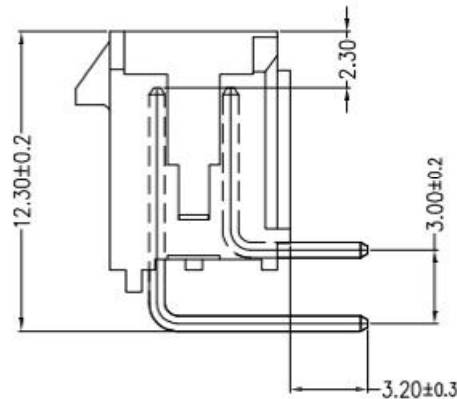
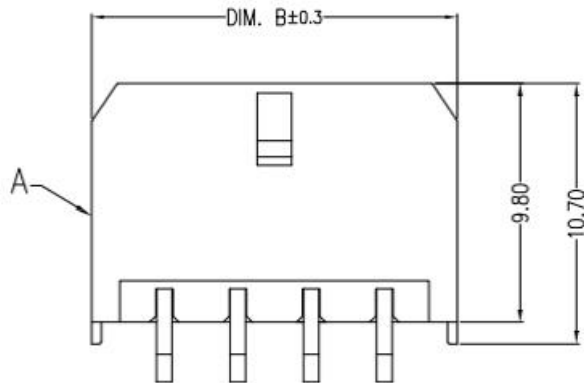

ORDER INFORMATION:

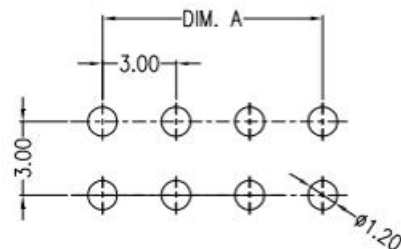
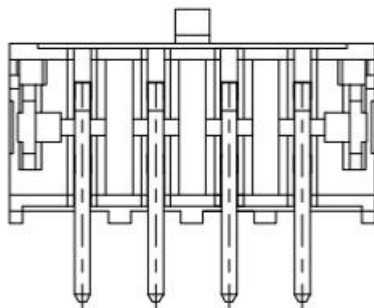
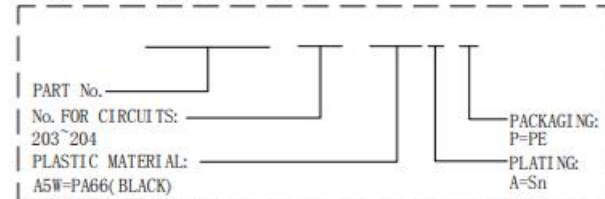

SUGGESTED PCB LAYOUT

STANDARD TOLERANCE
(EXCEPT SPECIFIED)

LINER	ANGLES
.0 ±0.30	0.° ±3°
.00 ±0.20	.0° ±2°
.000 ±0.10	.00° ±1°

广东科斯达开关厂

TITLE	A3001AW (MX3.0 Curved Needle)	DRAWN BY	LZM	11/21-'19
PART NO		CHECKED BY		
DRAWING NO		APPROVED BY		
SCALE	1:1	UNIT	mm	PAGE 1/1
				SIZE A4

ITEM	COMPONENT	Q'TY	MATERIAL	FINISH
B	CONTACT	2*3~2*4PCS	Brass	Sn-plated
A	PEDESTAL	1 PCS	PA66	UL 94V-0, COLOR:BLACK