

RoHS

REV	ECN NO	DESCRIPTION	DATE	NAME
A	—	NEW	11/21-'19	XXL

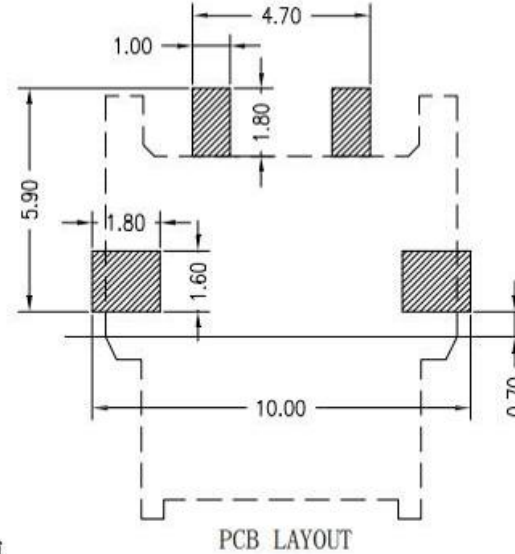
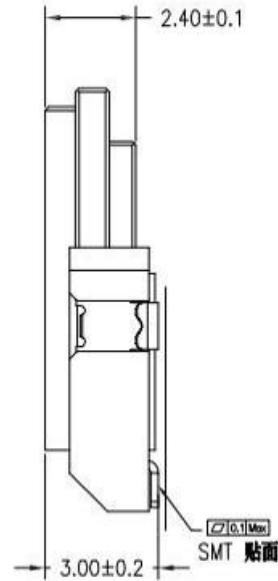
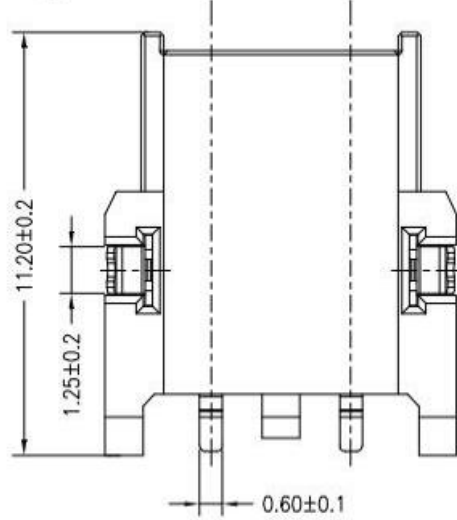
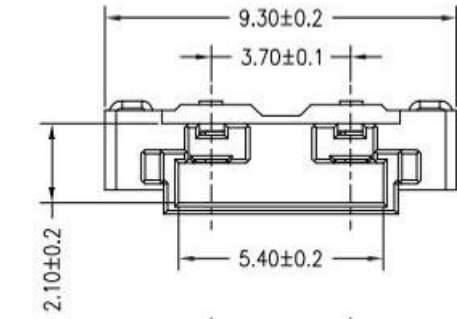
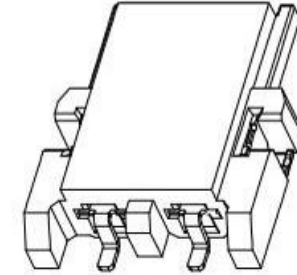

Main Specifications:

- 1.Poles:02p
- 2.Contact Resistance:30 mΩ max.
- 3.Insulator Resistance:1000 Megohms min.
- 4.Rated voltage:500v AC DC
- 5.Rated current:2.0A AC DC
- 6.Dielectric withstanding Voltage: AC 1500V/minute
- 7.-40°C to+85°C

Ordering Information

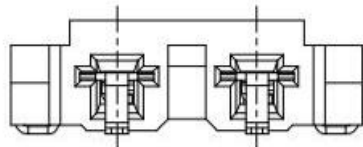
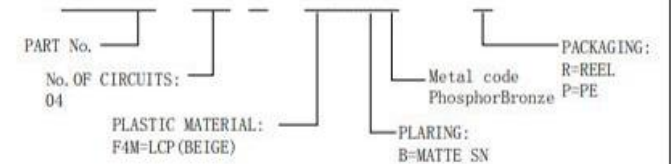

STANDARD TOLERANCE (EXCEPT SPECIFIED)

LINER	ANGLES
.0 ±0.30	0.° ±3°
.00 ±0.20	.0° ±2°
.000 ±0.10	.00° ±1°

广东科斯达开关厂									
TITLE		3.7MM PITCH 1X2P 90° WAFER SMT TYPE		DRAWN BY		XXL		11/21-'19	
PART NO.				CHECKED BY					
DRAWING NO.				APPROVED BY					
SCALE	1:1	UNIT	mm		PAGE	1/1	SIZE	A4	