

RoHS

REV	ECN NO	DESCRIPTION	DATE	NAME
A		NEW	6/1-'20	HYJ

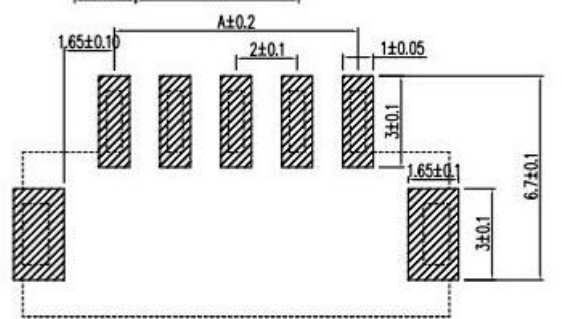

印制电路板

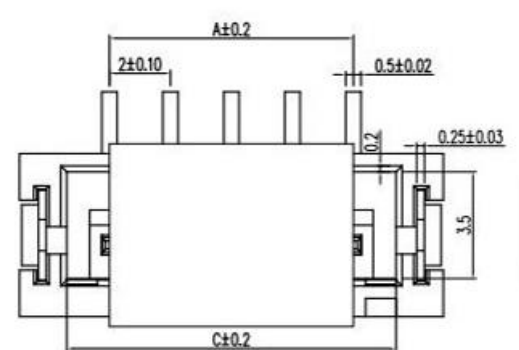
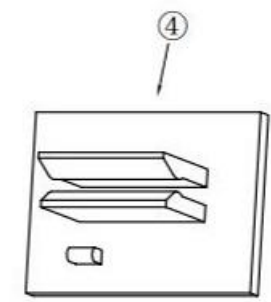
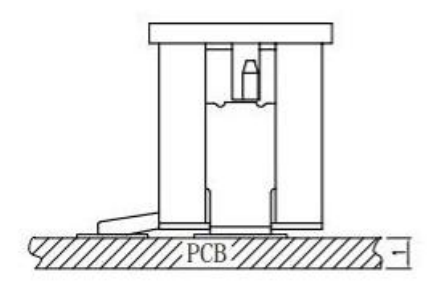
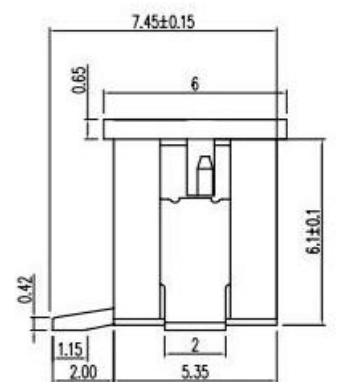
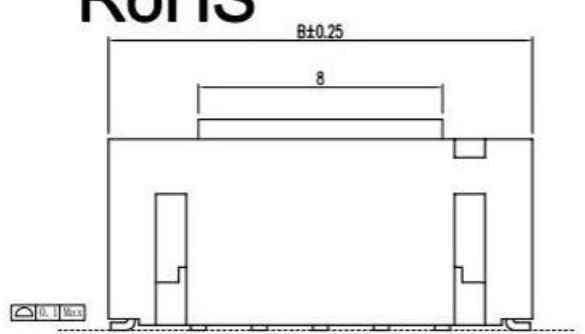
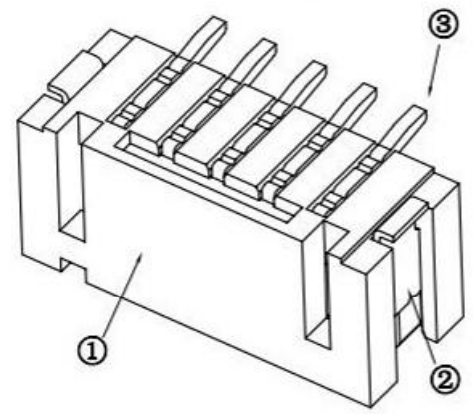

1. 技术参数:
- 1.1 额定电流: 2.0A AC/DC
 - 1.2 额定电压: 250V
 - 1.3 耐电压: 1000V ACminute
 - 1.4 接触电阻: 20mΩ MAX
 - 1.5 绝缘电阻: 1000MΩ MIN
 - 2. 工作温度: -25℃ ~ +85℃

PART No. _____
 No. OF CIRCUITS _____
 02~15
 PLASTIC MATERIAL _____
 F2M=LCP (BEIGE)
 SPECIAL CODE: CAP
 PACKAGING
 R=REEL
 P=PE
 PLATING
 A=MATTE Sn

Circuits	Dimensions (mm)			Circuits	Dimensions (mm)		
	A	B	C		A	B	C
2P	2.0	7.90	4.85	12P	22.0	27.9	24.85
3P	4.0	9.90	6.85	13P	24.0	29.9	26.85
4P	6.0	11.90	8.85	14P	26.0	31.9	28.85
5P	8.0	13.90	10.85	15P	28.0	33.9	30.85
6P	10.0	15.90	12.85	16P	30.0	35.9	32.85
7P	12.0	17.90	14.85	17P	32.0	37.9	34.85
8P	14.0	19.90	16.85	18P	34.0	39.9	36.85
9P	16.0	21.90	18.85	19P	36.0	41.9	38.85
10P	18.0	23.90	20.85	20P	38.0	43.9	40.85
11P	20.0	25.90	22.85				

TOLERANCE UNLESS OTHERWISE SPECIFIED

LINER	ANGLES
.0 ±0.30	0.° ±3°
.00 ±0.20	.0° ±2°
.000 ±0.10	.00° ±1°

NO	物料名称	规格型号	数量(PCS)	材质	镀涂
①	底座	2.0	1	LCPB130i	本色
②	焊片	2.0	2	黄铜	锡
③	插针	2.0	2~20	黄铜	锡
④	盖板	2.0	1	LCPB130i	本色

品名 连接器 图号

广东科斯达开关厂

TITLE	WAFER-L PR2.0 1XNP 立贴 带帽	DRAWN BY	HYJ	6/16-'20
PART NO		CHECKED BY		
DRAWING NO		APPROVED BY		
SCALE	1:1	UNIT	mm	PAGE 1/1 SIZE A4

标记	版本	更正记录	修订人	审核
△				
△				
△				

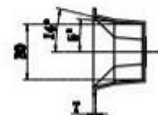
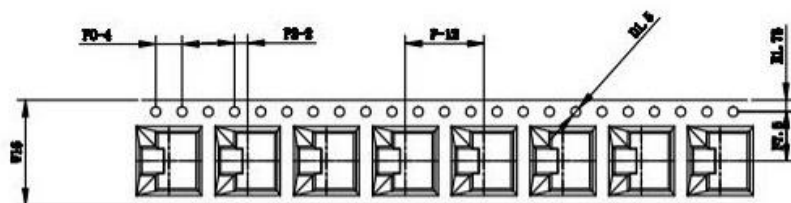

卷装示意图仅供参考

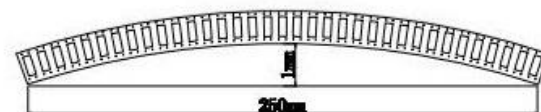
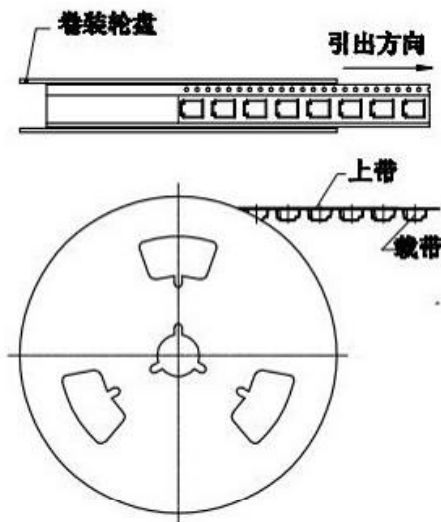

尺寸栏	
E	1.75±0.10
F	7.5±0.10
P2	2.00±0.10
∅D	1.50± $\begin{matrix} 0.10 \\ 0.00 \end{matrix}$
P0	4.00±0.10
W	16.00±0.30
P	12.0±0.10
A0	8.25±0.10
B0	8.35±0.10
K0	7.65±0.10
t	0.35±0.05

A-A

生产参数	
模数	93 模
颗数	744 颗
卷轮	330mm
包装数	700 颗

- 说明
- 10个边孔的累计公差不能超过±0.2mm.
 - 材料规格: PS 白色料抗静电, 厚度 0.35mm.
 - 13英寸卷轮卷装长度: 8.928米, 包装零件总颗数: 744颗, 每盘实包颗数: 700颗
 - 所有尺寸设计参照EIA-481-C-2003.
 - 载带在250mm长度内最大弯曲不能超过1mm见上图

广东科斯达开关厂

审核

产品名称: 连接器

产品型号: 1.0-0210

客户:

单位: mm

日期: 2019年9月11日

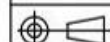

页次	比例	册本
1/1	1:1	00