

RoHS Compliant

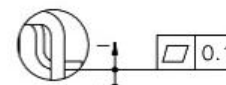

A RETAIL + COPLANARITY

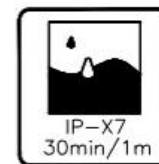
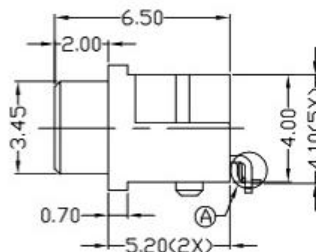
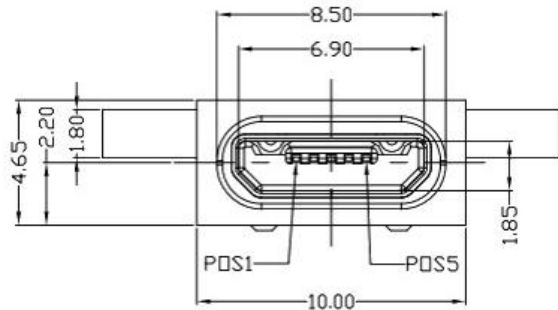
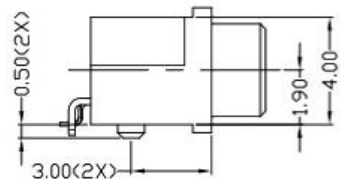
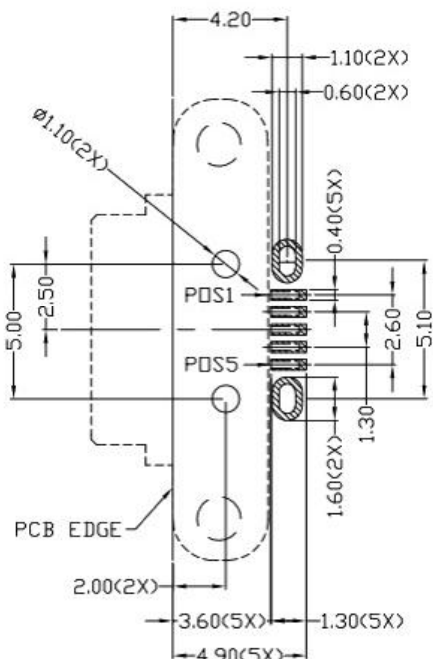
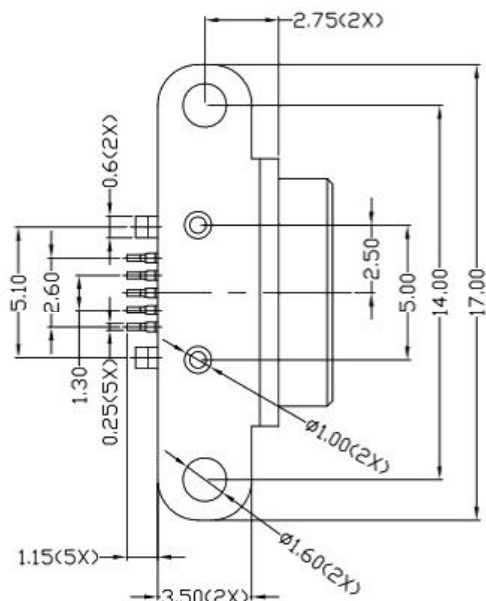

RECOMMENDED PCB LAYOUT
TOP VIEW

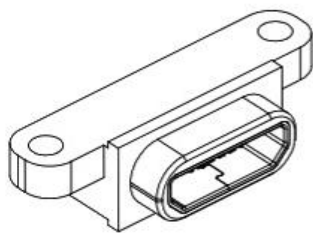

NOTES :

1. ELECTRICAL :

- 1) VOLTAGE CURRENT RATING: PIN 1,5:1.8A/30V AC Max.; PIN 2,3,4:0.5A/30V AC Max.
- 2) INSULATION RESISTANCE: 100MΩ MIN;
- 3) CONTACT RESISTANCE: 30mΩ MAX;
- 4) WITHSTANDING VOLTAGE: 300V AC;
- 5) OPERATING TEMPERATURE:-25°C TO +85°C.

2. Mechanical :

- 1) Mating Force: 35N MAX
- 2) Unmating Force: 8N MIN.

3. DIMENSIONS MARKED *▼* TO BE CHECKED BY Q.C & IPQC.

1: Au 1U*	W: WHITE
6: Au 30U*	B: BLACK
T: TIN	1: PBT
N: NICKEL	2: PA6T
	3: PA9T
	4: LCP
	7: PA10T

⑤ MID PLATE	1	STAINLESS STEEL	Au . PLATING.	T=0.15mm	
④ SHELL	1	STAINLESS STEEL	Au . PLATING.	T=0.30mm	
③ TERMINAL-B	1	TABLE 2:	TABLE 2:	T=0.12mm	
② TERMINAL-A	1	TABLE 2:	TABLE 2:	T=0.12mm	
① INSULATOR	1	HIGH TEMP	Black		
NO.	PART NAME	QTY	MATERIAL	DESCRIPTION	REMARK

UNLESS OTHERWISE, GENERAL TOLERANCE:

X.xxx	±0.10
X.xx	±0.20
X.x	±0.30
X.	±0.38

ANGULAR:	
X.xx	±1°
X.x	±3°
X.	±5°

广东科斯达开关厂

TITLE:	USB connector				P/N: Detail See PART NO. LIST
					MODEL:
					DRAW NO.:
THIRD ANGLE PROJECTION	UNIT:	SCALE:	SIZE:	SHEET:	
	mm	1:1	A4	1/1	

JH2016-080	X2	随工程图上升版本次	2016.06.15	陈少兵	DESIGN	陈少兵	2016.06.15	
JH2016-071	X1	新增规格	2016.06.10	陈少兵	CHECK	郑小伟	2016.06.15	
20151224001	X	NEW DRAWING	2016.05.05	陈少兵	APPROVAL	吕海涛	2016.06.15	
ECN NO.	REV.	DESCRIPTION	DATE	CHANGE				