

RoHS Compliant

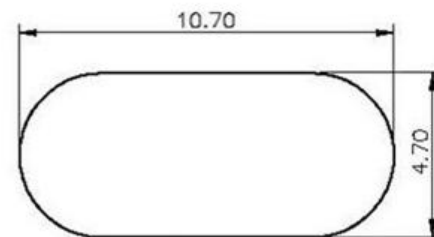

开孔尺寸参考
组装外壳时需要打环保润滑油

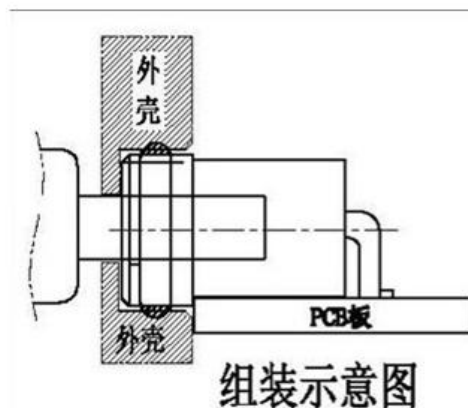
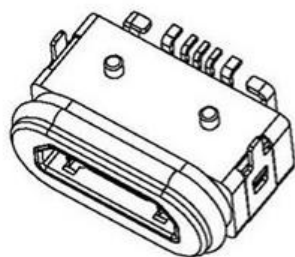
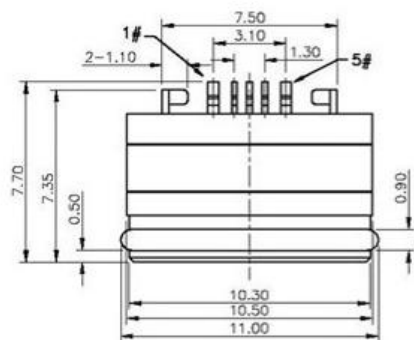
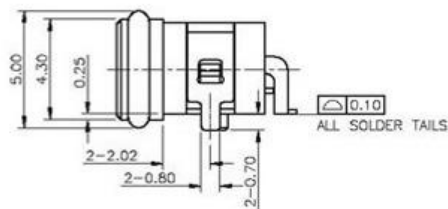
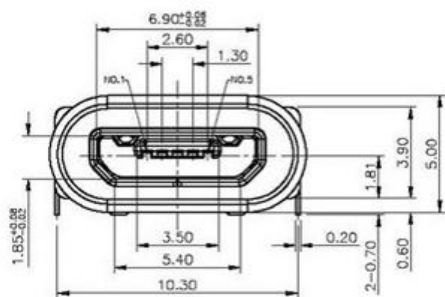

NOTES:

SPECIFICATION:

1. CURRENT RATING: 3.0A MAX
2. DIELECTRIC WITHSTAND VOLTAGE: 100VAC
3. TEMPERATURE RANGE: -30 °C ~ 85 °C
4. CONTACT RESISTANCE: 40 MILLIONHM MAX
5. INSULATION RESISTANCE: 100 MEGOHMS MIN.
6. INSERTION FORCE :8N~35N
7. UNMATING FORCE: 8N~35N
8. DURABILITY:1500 CYCLES

⑤	MID PLATE	1	STAINLESS STEEL	Au . PLATING.	T=0.15mm
④	SHELL	1	STAINLESS STEEL	Au . PLATING.	T=0.30mm
③	TERMINAL-B	1	TABLE 2:	TABLE 2:	T=0.12mm
②	TERMINAL-A	1	TABLE 2:	TABLE 2:	T=0.12mm
①	INSULATOR	1	HIGH TEMP	Black	

NO.	PART NAME	QTY	MATERIAL	DESCRIPTION	REMARK
-----	-----------	-----	----------	-------------	--------

UNLESS OTHERWISE,
GENERAL TOLERANCE:

X.xxx ±0.10
X.xx ±0.20
X.x ±0.30
X. ±0.38

ANGULAR:

X.xx ±1°
X.x ±3°
X. ±5°

广东科斯达开关厂

TITLE:
USB connector

P/N: Detail See PART NO. LIST

MODEL:

DRAW NO.:

THIRD ANGLE PROJECTION

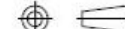

UNIT:

mm

SCALE:

1:1

SIZE:

A4

SHEET:

1/1

JH2016-080	X2	随工程图上升版本次	2016.06.15	陈少兵	DESIGN	陈少兵	2016.06.15
JH2016-071	X1	新增规格	2016.06.10	陈少兵	CHECK	郑小伟	2016.06.15
20151224001	X	NEW DRAWING	2016.05.05	陈少兵	APPROVAL	吕海涛	2016.06.15
ECN NO.	REV.	DESCRIPTION	DATE	CHANGE			