

RoHS Compliant

- NOTES:
- ELECTRICAL:
    - VOLTAGE CURRENT RATING: 2AMP, 30V AC;
    - INSULATION RESISTANCE: 1000MΩ, MIN;
    - CONTACT RESISTANCE: 30mΩ MAX;
    - WITHSTANDING VOLTAGE: 500V AC;
    - OPERATING TEMPERATURE: -55°C TO +85°C.
  - Mechanical:
    - Mating Force: 35N MAX
    - Unmating Force: 10N MIN.
  - NOTE: 1. DIMENSIONS MARKED "▼" TO BE CHECKED BY Q.C & IPQC.
  - PART NO.

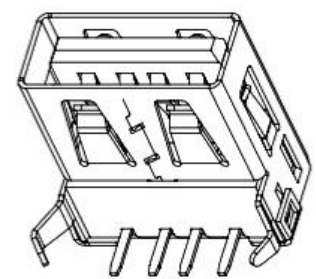
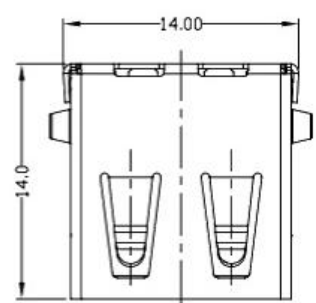

1: Au 1U\*  
6: Au 30U\*

W: WHITE  
B: BLACK

1: PBT  
2: PA6T  
3: PA9T  
4: LCP

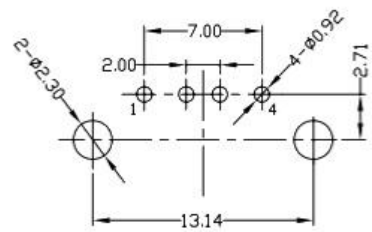
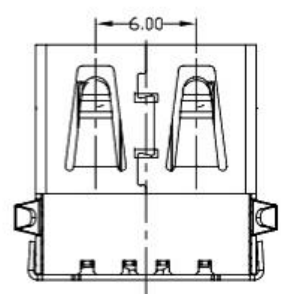
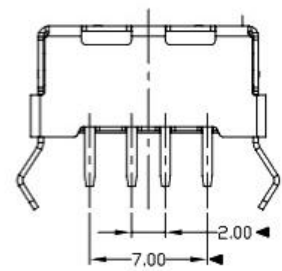
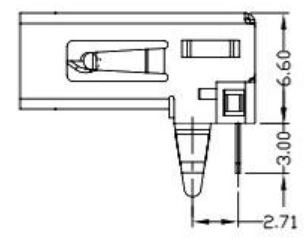
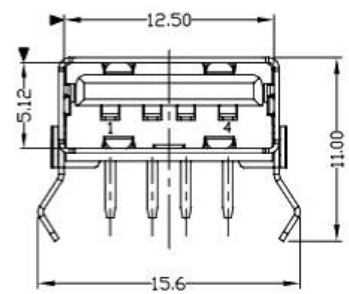

RECOMMENDED PCB LAYOUT

|   |            |   |                 |               |          |
|---|------------|---|-----------------|---------------|----------|
| ⑤ | MID PLATE  | 1 | STAINLESS STEEL | Au . PLATING. | T=0.15mm |
| ④ | SHELL      | 1 | STAINLESS STEEL | Au . PLATING. | T=0.30mm |
| ③ | TERMINAL-B | 1 | TABLE 2:        | TABLE 2:      | T=0.12mm |
| ② | TERMINAL-A | 1 | TABLE 2:        | TABLE 2:      | T=0.12mm |
| ① | INSULATOR  | 1 | HIGH TEMP       | Black         |          |

| NO. | PART NAME | QTY | MATERIAL | DESCRIPTION | REMARK |
|-----|-----------|-----|----------|-------------|--------|
|-----|-----------|-----|----------|-------------|--------|

UNLESS OTHERWISE, GENERAL TOLERANCE:

X.xxx ±0.10  
X.xx ±0.20  
X.x ±0.30  
X. ±0.38

ANGULAR:

X.xx ±1°  
X.x ±3°  
X. ±5°

广东科斯达开关厂

TITLE: **USB connector**

P/N: Detail See PART NO. LIST

MODEL: \_\_\_\_\_

DRAW NO.: \_\_\_\_\_

|                        |          |            |          |            |
|------------------------|----------|------------|----------|------------|
| THIRD ANGLE PROJECTION | UNIT: mm | SCALE: 1:1 | SIZE: A4 | SHEET: 1/1 |
|------------------------|----------|------------|----------|------------|

|             |      |             |            |        |          |     |            |
|-------------|------|-------------|------------|--------|----------|-----|------------|
| JH2016-080  | X2   | 随工程图上升版本次   | 2016.06.15 | 陈少兵    | DESIGN   | 陈少兵 | 2016.06.15 |
| JH2016-071  | X1   | 新增规格        | 2016.06.10 | 陈少兵    | CHECK    | 郑小伟 | 2016.06.15 |
| 20151224001 | X    | NEW DRAWING | 2016.05.05 | 陈少兵    | APPROVAL | 吕海涛 | 2016.06.15 |
| ECN NO.     | REV. | DESCRIPTION | DATE       | CHANGE |          |     |            |