

RoHS Compliant

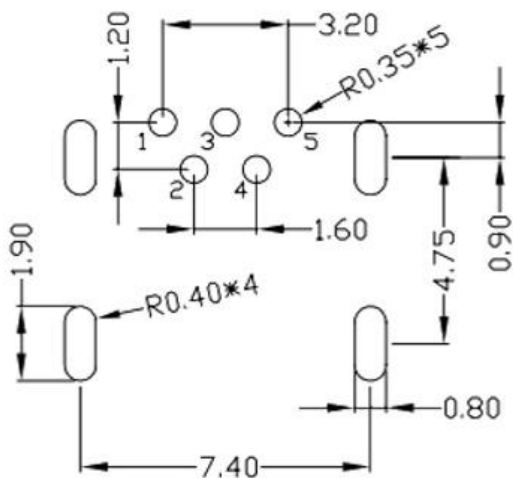
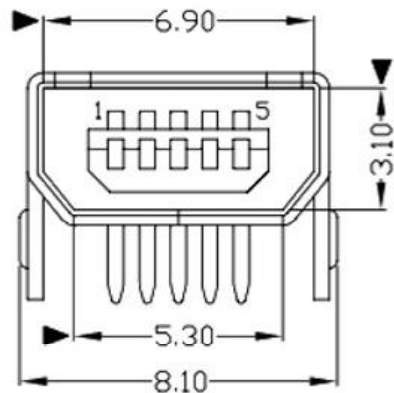
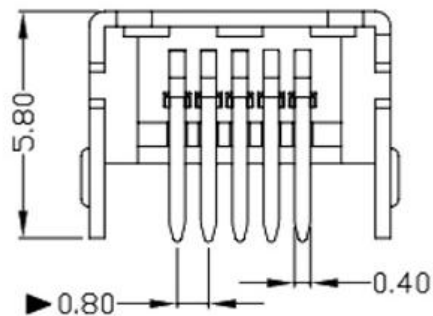
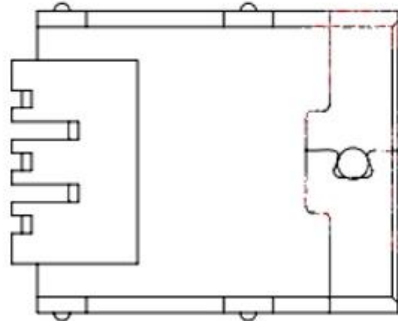
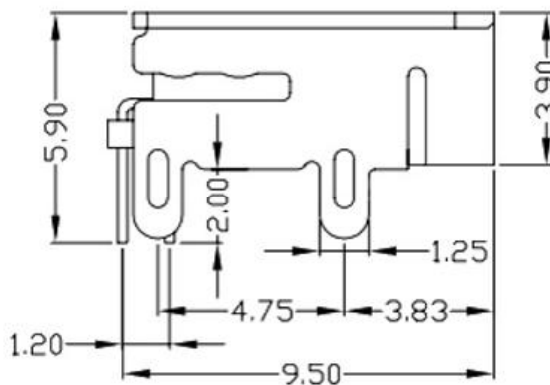
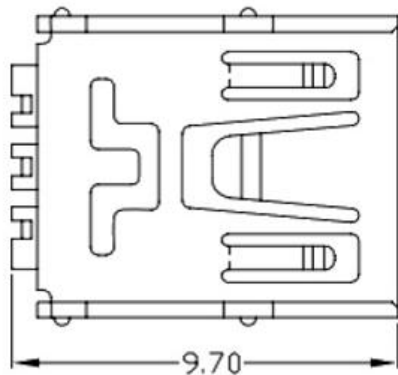

RECOMMENDED PCB LAYOUT

NOTES:

1. ELECTRICAL:

- 1) VOLTAGE CURRENT RATING: 1.0AMP,30V AC;
- 2) INSULATION RESISTANCE: 100MΩ MIN;
- 3) CONTACT RESISTANCE: 50mΩ MAX;
- 4) WITHSTANDING VOLTAGE: 300V AC;
- 5) OPERATING TEMPERATURE:-55°C TO +85°C.

2. Mechanical:

- 1) Mating Force: 30N MAX
- 2) Unmating Force: 7N MIN.

3. DIMENSIONS MARKED "▼" TO BE CHECKED BY Q.C & IPQC.

4.PART NO.

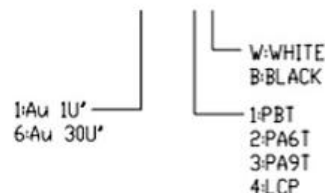

⑤	MID PLATE	1	STAINLESS STEEL	Au . PLATING.	T=0.15mm
④	SHELL	1	STAINLESS STEEL	Au . PLATING.	T=0.30mm
③	TERMINAL-B	1	TABLE 2:	TABLE 2:	T=0.12mm
②	TERMINAL-A	1	TABLE 2:	TABLE 2:	T=0.12mm
①	INSULATOR	1	HIGH TEMP	Black	

NO.	PART NAME	QTY	MATERIAL	DESCRIPTION	REMARK
-----	-----------	-----	----------	-------------	--------

UNLESS OTHERWISE, GENERAL TOLERANCE:

X.xxx	±0.10
X.xx	±0.20
X.x	±0.30
X.	±0.38

ANGULAR:

X.xx	±1°
X.x	±3°
X.	±5°

广东科斯达开关厂

TITLE:	P/N: Detail See PART NO. LIST			
USB connector	MODEL:			
DRAW NO.:				
THIRD ANGLE PROJECTION	UNIT:	SCALE:	SIZE:	SHEET:
	mm	1:1	A4	1/1

JH2016-080	X2	随工程图上升版本次	2016.06.15	陈少兵	DESIGN	陈少兵	2016.06.15
JH2016-071	X1	新增规格	2016.06.10	陈少兵	CHECK	郑小伟	2016.06.15
20151224001	X	NEW DRAWING	2016.05.05	陈少兵	APPROVAL	吕海涛	2016.06.15
ECN NO.	REV.	DESCRIPTION	DATE	CHANGE			