

RoHS Compliant

NOTES:

1. ELECTRICAL:
 - 1) VOLTAGE CURRENT RATING: 2AMP, 30V DC;
 - 2) INSULATION RESISTANCE: 1000MΩ MIN;
 - 3) CONTACT RESISTANCE: 30mΩ MAX;
 - 4) WITHSTANDING VOLTAGE: 500V AC;
 - 5) OPERATING TEMPERATURE: -55°C TO +85°C.
2. Mechanical:
 - 1) Mating Force: 35N MAX
 - 2) Unmating Force: 10N MIN.
3. NOTE: 1. DIMENSIONS MARKED "▼" TO BE CHECKED BY Q.C & IPQC.

4. PART NO.

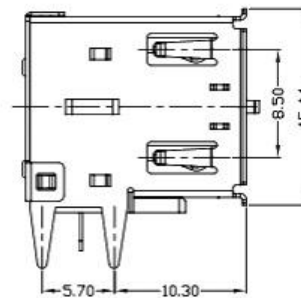
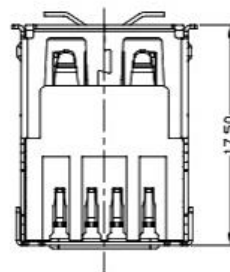
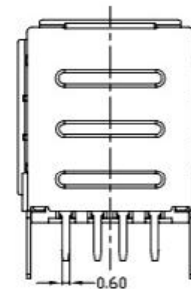
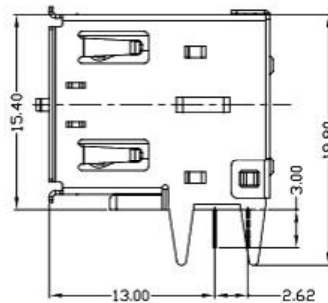
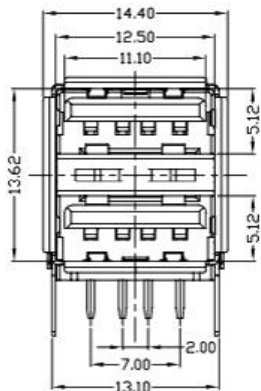
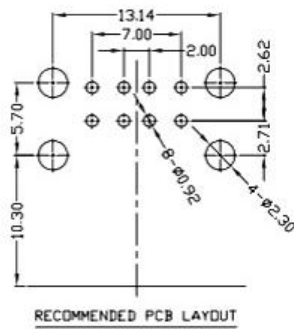
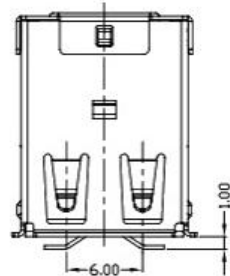
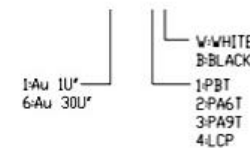

⑤	MID PLATE	1	STAINLESS STEEL	Au . PLATING.	T=0.15mm
④	SHELL	1	STAINLESS STEEL	Au . PLATING.	T=0.30mm
③	TERMINAL-B	1	TABLE 2:	TABLE 2:	T=0.12mm
②	TERMINAL-A	1	TABLE 2:	TABLE 2:	T=0.12mm
①	INSULATOR	1	HIGH TEMP	Black	
NO.	PART NAME	QTY	MATERIAL	DESCRIPTION	REMARK

UNLESS OTHERWISE, GENERAL TOLERANCE:

- X.xxx ±0.10
- X.xx ±0.20
- X.x ±0.30
- X. ±0.38

ANGULAR:

- X.xx ±1°
- X.x ±3°
- X. ±5°

广东科斯达开关厂

TITLE:		P/N: Detail See PART NO. LIST		
USB connector		MODEL:		
DRAW NO.:				
THIRD ANGLE PROJECTION	UNIT:	SCALE:	SIZE:	SHEET:
	mm	1:1	A4	1/1

JH2016-080	X2	随工程图上升版本次	2016.06.15	陈少兵	DESIGN	陈少兵	2016.06.15
JH2016-071	X1	新增规格	2016.06.10	陈少兵	CHECK	郑小伟	2016.06.15
20151224001	X	NEW DRAWING	2016.05.05	陈少兵	APPROVAL	吕海涛	2016.06.15
ECN NO.	REV.	DESCRIPTION	DATE	CHANGE			