

RoHS Compliant

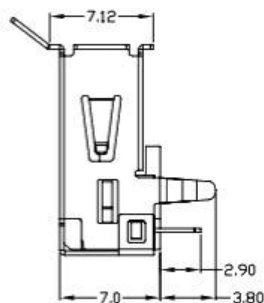
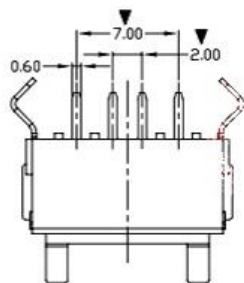
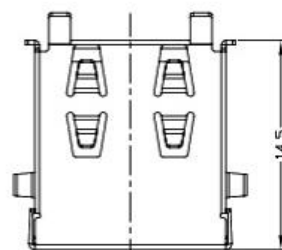
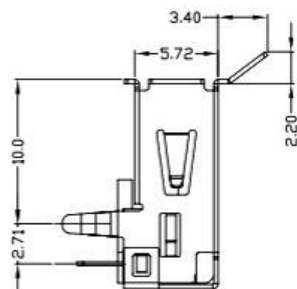
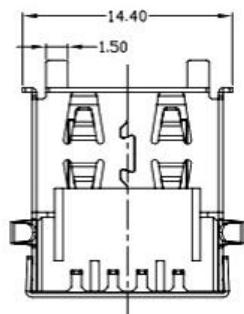
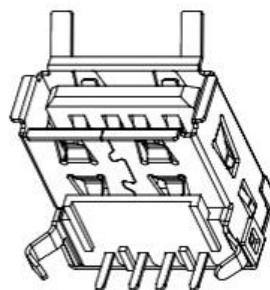
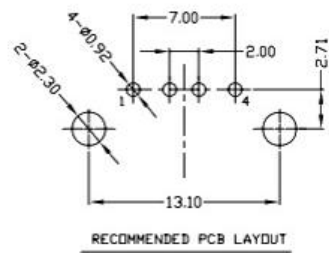
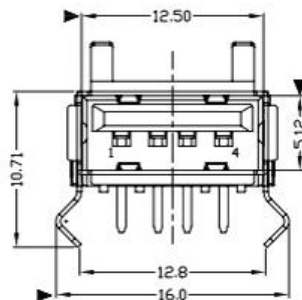

NOTES:

1. ELECTRICAL:

- 1) VOLTAGE CURRENT RATING: 2AMP, 30V AC;
- 2) INSULATION RESISTANCE: 1000MΩ MIN;
- 3) CONTACT RESISTANCE: 30mΩ MAX;
- 4) WITHSTANDING VOLTAGE: 500V AC;
- 5) OPERATING TEMPERATURE: -55°C TO +85°C.

2. Mechanical:

- 1) Mating Force: 35N MAX
- 2) Unmating Force: 10N MIN.

3. NOTE: 1. DIMENSIONS MARKED "▼" TO BE CHECKED BY Q.C & IPQC.

4. PART NO.

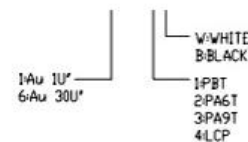

| ⑤ | MID PLATE | 1 | STAINLESS STEEL | Au . PLATING. | T=0.15mm |
|-----|------------|-----|-----------------|---------------|----------|
| ④ | SHELL | 1 | STAINLESS STEEL | Au . PLATING. | T=0.30mm |
| ③ | TERMINAL-B | 1 | TABLE 2: | TABLE 2: | T=0.12mm |
| ② | TERMINAL-A | 1 | TABLE 2: | TABLE 2: | T=0.12mm |
| ① | INSULATOR | 1 | HIGH TEMP | Black | |
| NO. | PART NAME | QTY | MATERIAL | DESCRIPTION | REMARK |

UNLESS OTHERWISE, GENERAL TOLERANCE:

- X.xxx ±0.10
- X.xx ±0.20
- X.x ±0.30
- X. ±0.38

ANGULAR:

- X.xx ±1°
- X.x ±3°
- X. ±5°

广东科斯达开关厂

| | | | | |
|------------------------|------------|-------------------------------|------------|--|
| TITLE: USB connector | | P/N: Detail See PART NO. LIST | | |
| THIRD ANGLE PROJECTION | | DRAW NO.: _____ | | |
| UNIT: mm | SCALE: 1:1 | SIZE: A4 | SHEET: 1/1 | |

| JH2016-080 | X2 | 随工程图上升版本次 | 2016.06.15 | 陈少兵 | DESIGN | 陈少兵 | 2016.06.15 | |
|-------------|------|-------------|------------|--------|----------|-----|------------|--|
| JH2016-071 | X1 | 新增规格 | 2016.06.10 | 陈少兵 | CHECK | 郑小伟 | 2016.06.15 | |
| 20151224001 | X | NEW DRAWING | 2016.05.05 | 陈少兵 | APPROVAL | 吕海涛 | 2016.06.15 | |
| ECN NO. | REV. | DESCRIPTION | DATE | CHANGE | | | | |