

RoHS Compliant

NOTES:

1. ELECTRICAL:
 - 1) CURRENT RATING: 3AMP MAX;
 - 2) INSULATION RESISTANCE: 100MΩ MIN 250V DC;
 - 3) CONTACT RESISTANCE: 30mΩ MAX;
 - 4) WITHSTANDING VOLTAGE: 250V AC;
 - 5) OPERATING TEMPERATURE: -30°C TO +85°C.
2. Mechanical:
 - 1) Mating Force: 5N~20N
 - 2) Unmating Force: 8N~20N
3. DIMENSIONS MARKED "▽" TO BE CHECKED BY Q.C & IPQC.
4. PART NO.

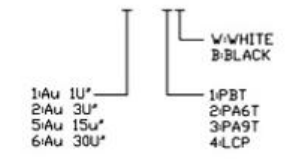
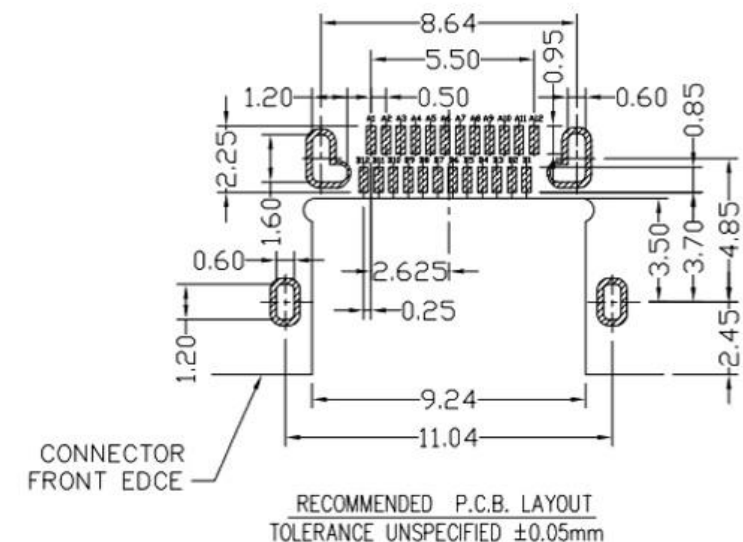
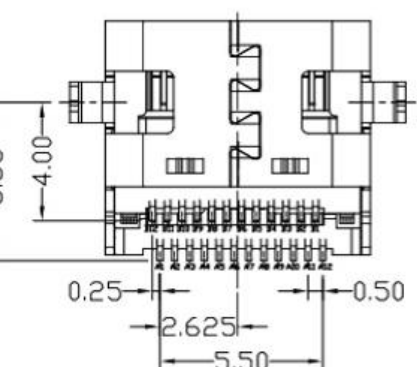
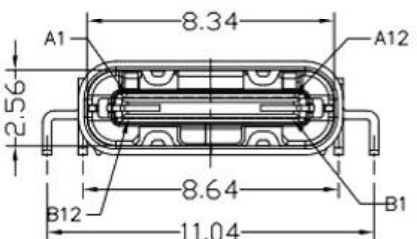
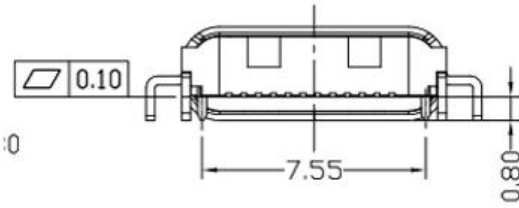
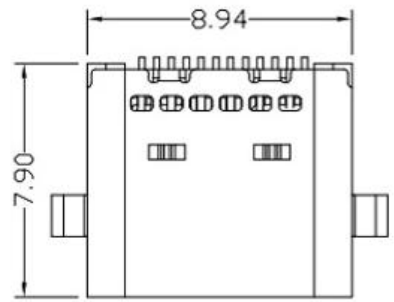
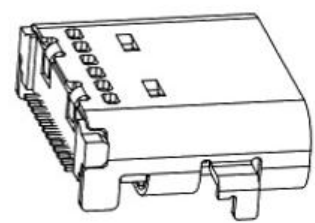
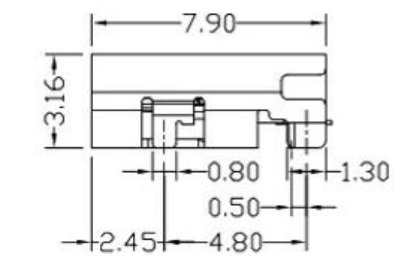

A1	GND	B12	GND
A2	SSTXP1	B11	SSRXP1
A3	SSTXN1	B10	SSRXN1
A4	VBUS	B9	VBUS
A5	CC1	B8	SBU2
A6	DP1	B7	DN2
A7	DN1	B6	DP2
A8	SBU1	B5	CC2
A9	VBUS	B4	VBUS
A10	SSRXN2	B3	SSTXN2
A11	SSRXP2	B2	SSTXP2
A12	GND	B1	GND
PIN	SIGNAL NAME	PIN	SIGNAL NAME

⑤	MID PLATE	1	STAINLESS STEEL	Au . PLATING.	T=0.15mm
④	SHELL	1	STAINLESS STEEL	Au . PLATING.	T=0.30mm
③	TERMINAL-B	1	TABLE 2:	TABLE 2:	T=0.12mm
②	TERMINAL-A	1	TABLE 2:	TABLE 2:	T=0.12mm
①	INSULATOR	1	HIGH TEMP	Black	
NO.	PART NAME	QTY	MATERIAL	DESCRIPTION	REMARK

UNLESS OTHERWISE SPECIFIED:
GENERAL TOLERANCE:
X.xxx ±0.10
X.xx ±0.20
X.x ±0.30
X. ±0.38
ANGULAR:
X.xx ±1°
X.x ±3°
X. ±5°

广东科斯达开关厂

TITLE: USB connector

P/N: Detail See PART NO. LIST

MODEL:

DRAW NO.:

THIRD ANGLE PROJECTION

UNIT: mm

SCALE: 1:1

SIZE: A4

SHEET: 1/1

JH2016-080	X2	随工程图上升版本次	2016.06.15	陈少兵	DESIGN	陈少兵	2016.06.15	
JH2016-071	X1	新增规格	2016.06.10	陈少兵	CHECK	郑小伟	2016.06.15	
20151224001	X	NEW DRAWING	2016.05.05	陈少兵	APPROVAL	吕海涛	2016.06.15	
ECN NO.	REV.	DESCRIPTION	DATE	CHANGE				