

F

E

D

C

B

A

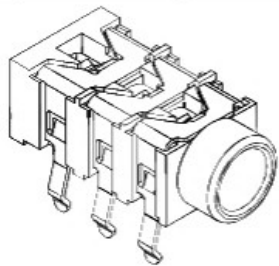

ZONE	SYMBOL	REVISION	APPROVAL	DATE
		DESIGN MODIFIED	J.X.KLANG	31-5-2017

RoHS  
Compliant

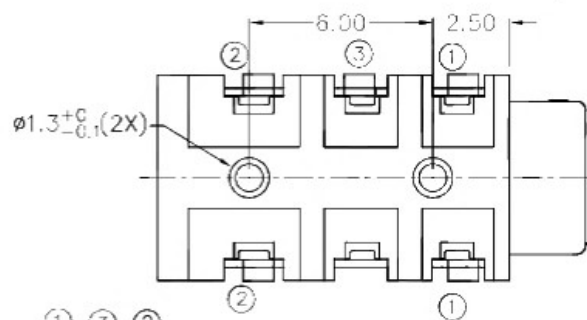
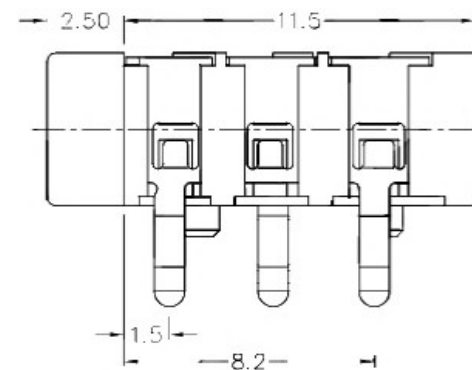
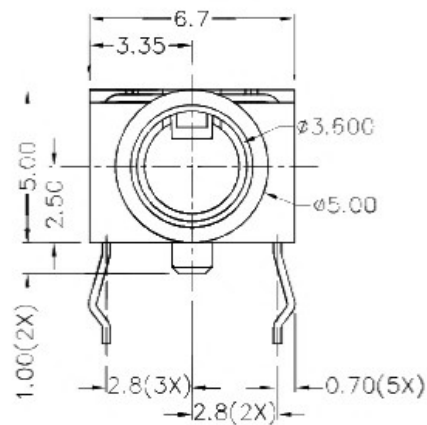
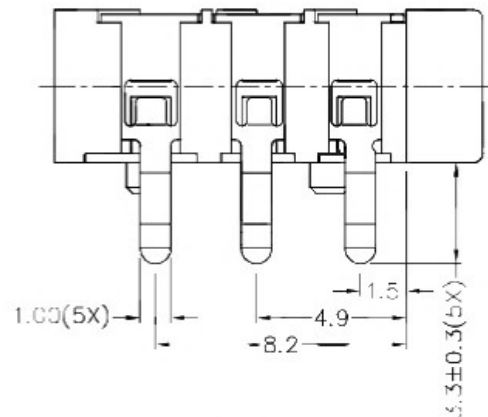

\* MATERIAL

TERMINAL 1 : COPPER ALLOY  
 TERMINAL 2 : COPPER ALLOY  
 TERMINAL 3 : COPPER ALLOY  
 HOUSING : THERMOPLASTIC

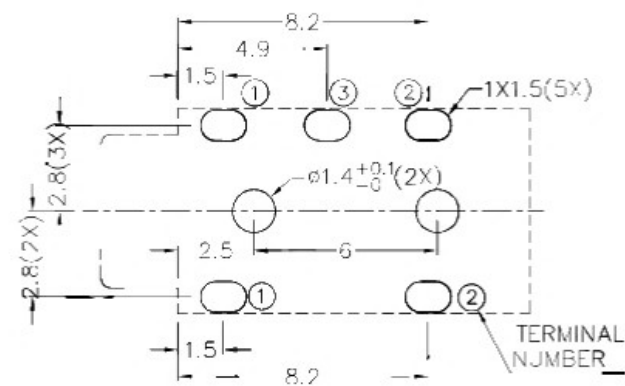

RECOMMENDED PCB LAYOUT  
 TOLERANCE: ±0.05  
 (TOP VIEW)

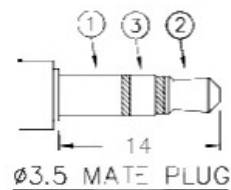
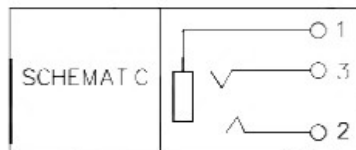

 广东科斯达开关厂

PART NAME	3.5mm STEREO JACK	TOLERANCE UNLESS OTHERWISE SPECIFIED:	0.0±0.2 0.00±0.1 0.000±0.05	UNIT:	
PART NO.					

DESIGN	Y.J.GUO	DATE	31-5-2017	SCALE	4:1
DRAWING	H.L.IAN	DATE	31-5-2017	MATERIAL	×
CHECK	T.Y.LI	DATE	31-5-2017	DWG. NO.	TZ\SH354-B/2.0
APPROVAL		DATE		SHEET	

F

E

D

C

B

A