

REV.	ECN NO.	DESCRIPTION	DESIGN	DATE
A		INITIAL	Kai	2018.03.29

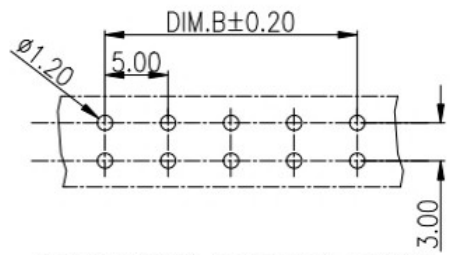

RECOMMENDED P.C. BOARD LAYOUT

NOTE:
 Material
 Insulator:Nylon 9T(UL94V-0)
 Contact:phosphor Bronze
 Contact Plated:Gold over Nickel or Tin
 Specification
 Rated voltage: 12V 30V
 Current rating: 3A 5A
 instant CURRENT:7A
 Contact Resistance:30MΩ
 Insulation Resistance:100MΩ
 Dielectric Voltage:1000V
 Operdting Temperature:-40°~105°

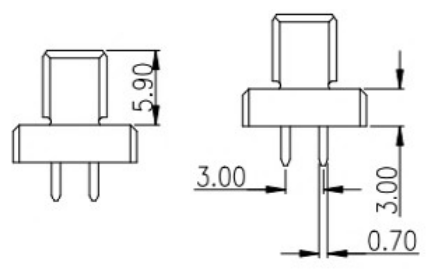
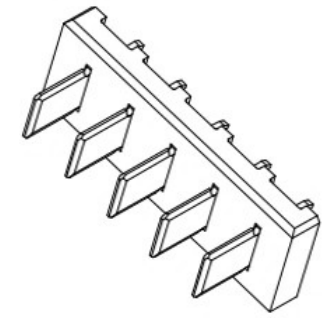
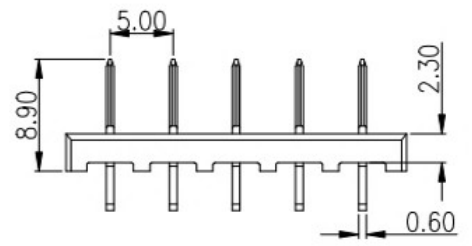
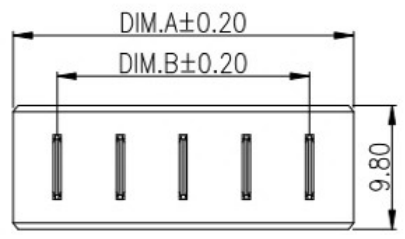
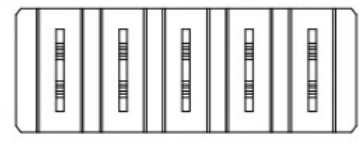

PIN	Dim.A	Dim.B
02pin	12.00	5.00
03pin	17.00	10.00
04pin	22.00	15.00
05pin	27.00	20.00

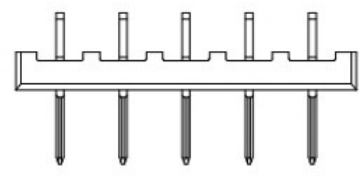

UNLESS OTHERWISE SPECIFIED TOLERANCES

广东科斯达电器开关厂

DECIMALS:	ANGLES:	DWG NO.	PART NAME:
DIM TOL	DIM TOL	DESIGN:	PART NO.
X. ±0.50	X. ±2°	CHECK:	REV. UNIT: SHEET:
X.X ±0.30	X.X ±1°	APPROVED	A mm 1/1
X.XX ±0.20	X.XX		
X.XXX ±0.10	X.XXX		

ITEM	PART NAME	Q'TY	MATERTAL	DESCRIPTION	REMARK
②	HOUSING	1	LCP		BLACK
①	CONTACT A	2	PHOSPHOR BRONZE 0.20T	Au PLATED	