

REV.	ECN NO.	DESCRIPTION	DESIGN	DATE
A		INITIAL	Kai	2018.03.29

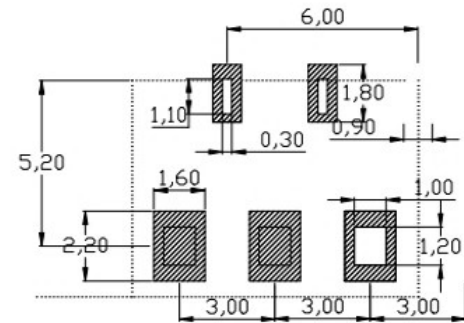

RECOMMENDED PCB LAYOUT
TOP VIEW(. XX±0.05)

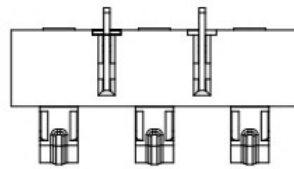
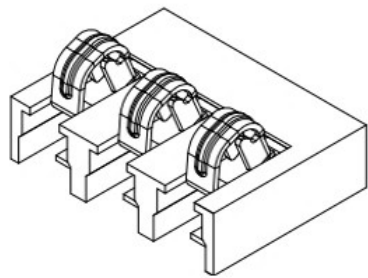
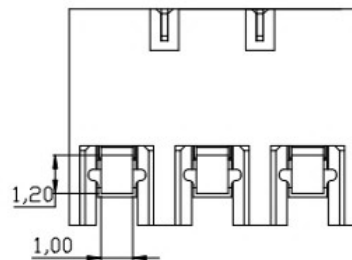
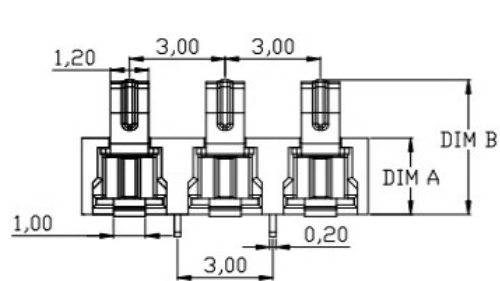
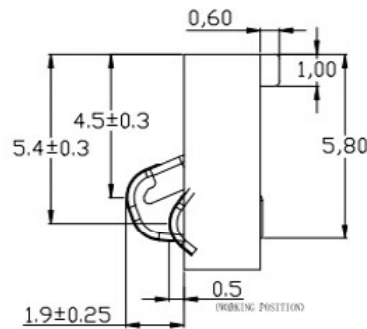
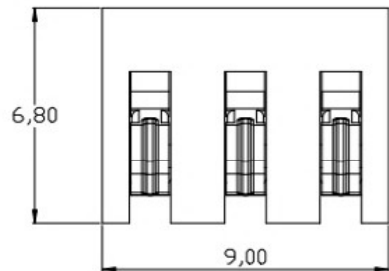

DIM A	DIM B
2.4	4.30±0.25
3.5	5.40±0.25

性能:

额定电流: 3.0A

额定电压: 24V

耐电压: 500V

接触电阻: 30mΩ MAX

绝缘电阻: 500MΩ

工作温度: -40℃~+85℃

塑件(材质): LCP, 耐高温260℃

接触点(材质): 铜合金, 触点镀金3U'

UNLESS OTHERWISE SPECIFIED TOLERANCES

广东科斯达电器开关厂

DECIMALS:		ANGLES:		DWG NO.	PART NAME:
DIM	TOL	DIM	TOL	DESIGN:	PART NO.
X.	±0.50	X.	±2°	CHECK:	REV.
X.X	±0.30	X.X	±1°	APPROVED	UNIT:
X.XX	±0.20	X.XX	---		SHEET:
X.XXX	±0.10	X.XXX	---		1/1

ITEM	PART NAME	Q'TY	MATERTAL	DESCRIPTION	REMARK
②	HOUSING	1	LCP		BLACK
①	CONTACT A	2	PHOSPHOR BRONZE 0.20T	Au PLATED	