

REV.	ECN NO.	DESCRIPTION	DESIGN	DATE
A		INITIAL	Kai	2018.03.29

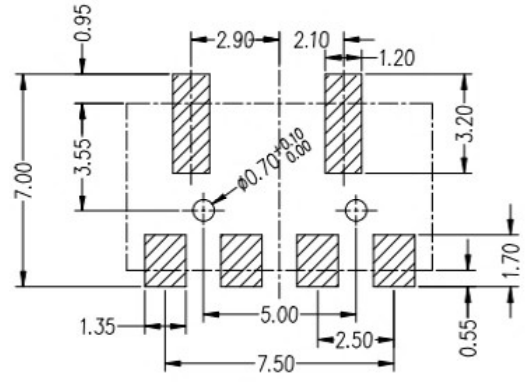

RECOMMENDED PCB LAYOUT  
TOL:(±0.05)

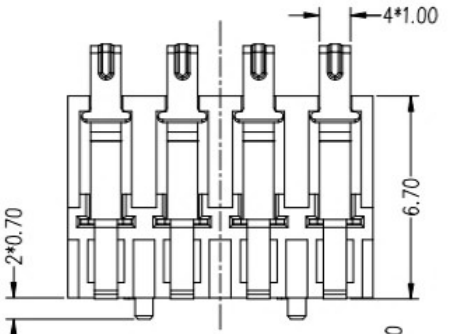
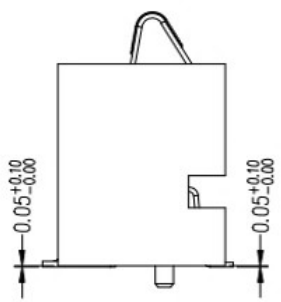
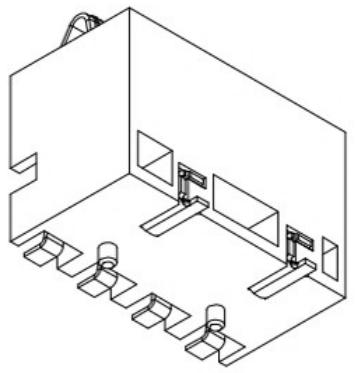
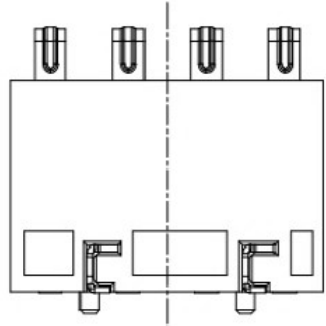
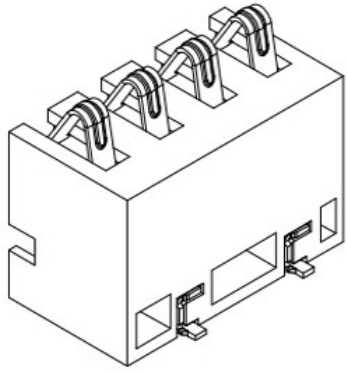
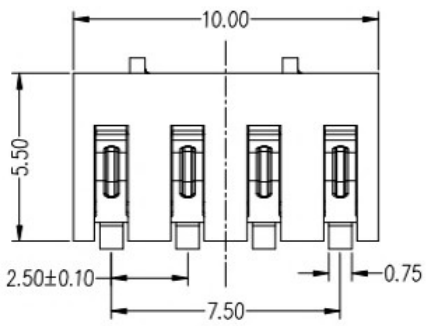
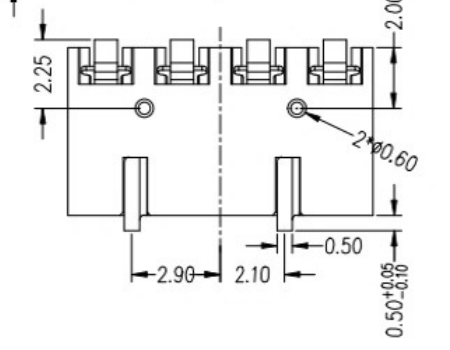
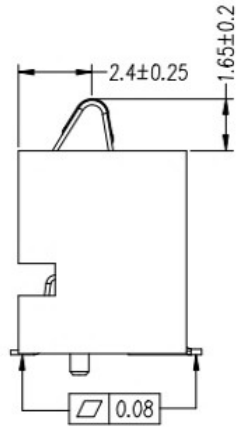

性能:  
 额定电流: 3.0A  
 额定电压: 24V  
 耐电压: 500V  
 接触电阻: 30mΩ MAX  
 绝缘电阻: 500MΩ  
 工作温度: -40℃~+85℃  
 塑件(材质): LCP, 耐高温260℃  
 接触点(材质): 铜合金, 触点镀金3U'

UNLESS OTHERWISE SPECIFIED TOLERANCES				广东科斯达电器开关厂			
DECIMALS:		ANGLES:		DWG NO.	PART NAME:		
DIM	TOL	DIM	TOL	DESIGN:	PART NO.		
X.	±0.50	X.	±2°	CHECK:	REV.		UNIT: mm
X.X	±0.30	X.X	±1°	APPROVED	A	SHEET: 1/1	
X.XX	±0.20	X.XX	----				
X.XXX	±0.10	X.XXX	----				

②	HOUSING	1	LCP		BLACK
①	CONTACT A	2	PHOSPHOR BRONZE 0.20T	Au PLATED	
ITEM	PART NAME	Q'TY	MATERIAL	DESCRIPTION	REMARK